

User Manual

F19P – 3U CompactPCI® PlusIO Intel® Core™ 2 Duo CPU Board



F19P - 3U CompactPCI® PlusIO Intel® Core™ 2 Duo CPU Board

The F19P versatile 4HP/3U single-board computer is a continuation of MEN's proven range of Intel® CPU boards. It is equipped with the Intel® Core 2 Duo processor SP9300 running at 2.26 GHz and offering multi-core processor architecture from Intel® with full 64-bit support. The CPU card delivers an excellent graphics performance and is designed especially for embedded systems which require high computing performance with low power consumption.

The F19P offers a 32-bit/33-MHz CompactPCI® bus interface and can also be used without a bus system. It offers 4 USB 2.0 and 4 fast (3Gb/s) SATA interfaces as well as 4 PCI Express® x1 links and one Gigabit Ethernet on the J2 rear I/O connector which is compatible with the PICMG 2.30 CompactPCI® PlusIO specification.

A total of seven PCI Express® lanes for high-speed communication (such as Gigabit Ethernet) are supported on the F19P. 3 x1 PCIe® links are used for the three onboard Ethernet interfaces. 4 x1 PCIe® links are available via rear I/O or on a specific side card.

The F19P is equipped with DDR3 DRAM which is soldered to the F19P to guarantee optimum shock and vibration resistance. A robust CompactFlash® and microSD™ card device which are connected via a USB interface offer nearly unlimited space for user applications.

The standard I/O available at the front panel of F19P includes graphics on a VGA connector, two PCIe®-driven Gigabit Ethernet as well as two USB 2.0 ports.

The F19P can be extended by different side cards. Additional functions include two digital video interfaces for flat panel connection via DVI (multimedia), a variety of different UARTs or another four USBs, SATA for hard disk connection and HD audio.

Thermal supervision of the processor and a watchdog for the operating system complete the functionality of the F19P.

The F19P operates in Windows® and Linux environments as well as under real-time operating systems that support Intel®'s multi-core architecture. The InsydeH2O™ EFI BIOS was specially designed for embedded system applications.

Equipped with Intel® components exclusively from the Intel® Embedded Line, the F19P has a guaranteed minimum standard availability of 7 years.

The F19P is suited for a wide range of industrial applications, e.g. for monitoring, vision and control systems as well as test and measurement.

The F19P comes with a tailored passive heat sink within 4 HP height. The robust design of the F19P make the board especially suited for use in rugged environments with regard to shock and vibration according to applicable DIN, EN or IEC industry standards. The F19P is also ready for coating so that it can be used in humid and dusty environments.

Diagram

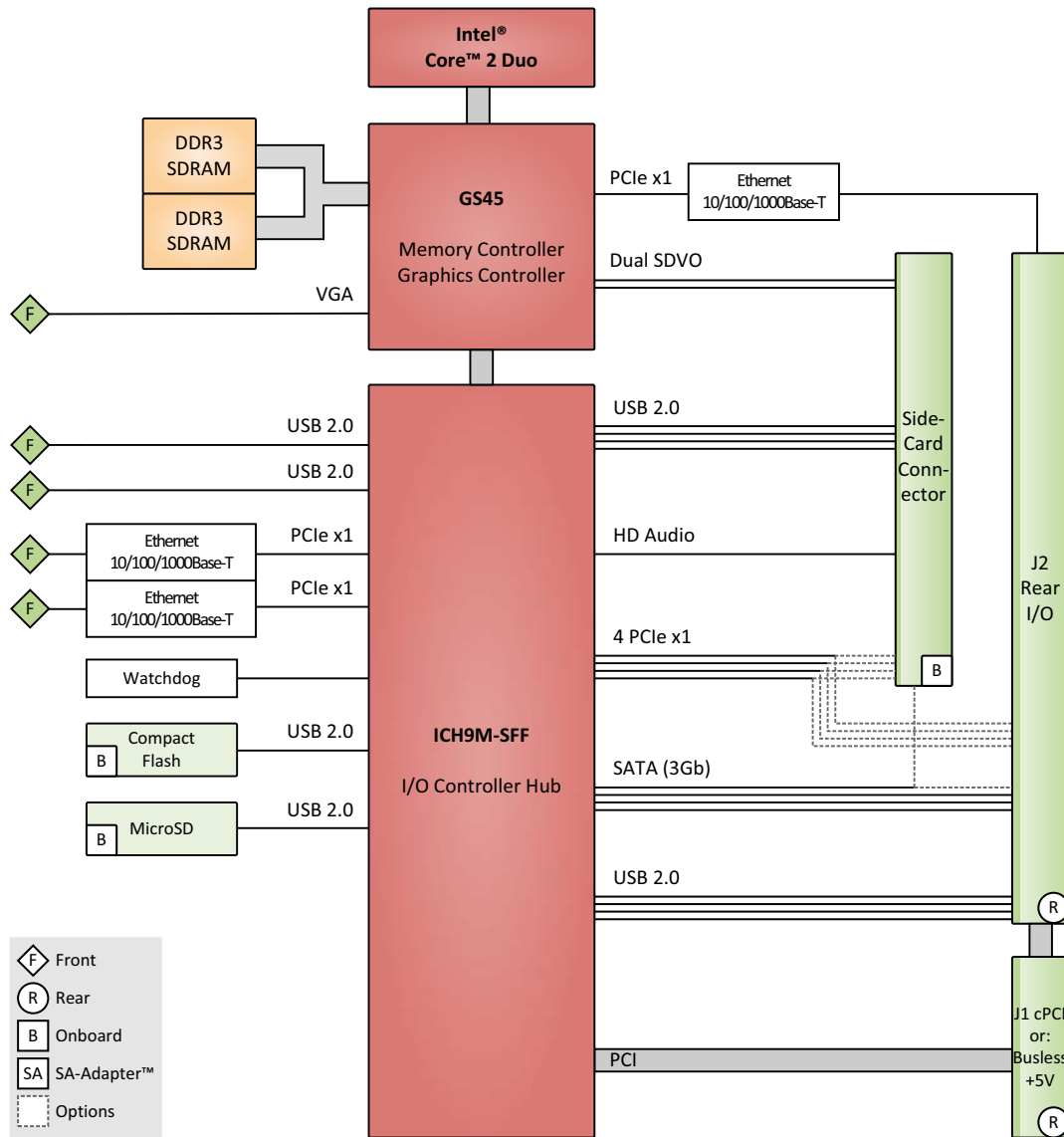

Technical Data

CPU

- Intel® Core™ 2 Duo SP9300
 - Up to 2.26 GHz processor core frequency
 - 1066 MHz system bus frequency
- Chipset
 - Northbridge: Intel® GS45
 - Southbridge: Intel® ICH9M-SFF

Memory

- Up to 6 MB L2 cache integrated in Core 2 Duo
- Up to 4 GB DDR3 SDRAM system memory
 - Soldered
 - 800/1067 MHz memory bus frequency locked to the FSB frequency
- 16 Mbits boot Flash
- Serial EEPROM 2kbits for factory settings
- CompactFlash® card interface
 - Via USB
 - Type I
 - True IDE
 - DMA support
- MicroSD card interface
 - Via USB

Mass Storage

- CompactFlash®
 - Connected via USB
- MicroSD card
 - Connected via USB
- Serial ATA (SATA)
 - Four channels via rear I/O, one channel via side-card connector (switchable)
 - Transfer rates up to 3 Gbit/s
 - RAID level 0/1 support

Graphics

- Integrated in GS45 chipset
 - Up to 533 MHz graphics core
 - Maximum resolution: 2048 x 1536 pixels
- VGA connector at front panel
- Two SDVO ports available via side-card connector
 - Two additional DVI connectors at front panel optional via side card
 - Simultaneous connection of two monitors

I/O

- USB
 - Two USB 2.0 ports via Series A connectors at front panel
 - Four USB 2.0 ports via side-card connector
 - Four USB 2.0 ports via rear I/O
 - One USB for connection of CompactFlash®/MicroSD or USB NAND Flash
 - UHCI implementation
 - Data rates up to 480Mbit/s
- Ethernet
 - Two 10/100/1000Base-T Ethernet channels at the front
 - RJ45 connectors at front panel
 - Ethernet controllers are connected by two x1 PCIe® links from ICH9M
 - Onboard LEDs to signal activity status and connection speed
 - One 10/100/1000Base-T Ethernet channel via rear I/O
 - Ethernet controller is connected by one x1 PCIe® link from GS45
- High Definition (HD) audio
 - Accessible via side-card connector

Front Connections (Standard)

- VGA
- Two USB 2.0 (Series A)
- Two Ethernet (RJ45)

Rear I/O

- Four SATA
- Four USB
- One Gigabit Ethernet
- Four PCI Express® x1 links
- Compatible with PICMG 2.30 CompactPCI® PlusIO
 - 1PCI33/4PCIE2.5/4SATA3/4USB2/1ETH1G

Miscellaneous

- Board controller
- Real-time clock, buffered by a GoldCap or alternatively a battery (5 years life cycle)
- Watchdog timer
- Temperature measurement
- One user LED
- Reset button

PCI Express®

- Three x1 links to connect local 1000Base-T Ethernet controllers
 - Data rate 250 MB/s in each direction (2.5 Gbit/s per lane)
- Four x1 links for extension through side-card connector or rear I/O
 - Data rate up to 1 GB/s in each direction (2.5 Gbit/s per lane)

CompactPCI® Bus

- Compliance with CompactPCI® Core Specification PICMG 2.0 R3.0
- System slot
- 32-bit/33-MHz CompactPCI® bus
- V(I/O): +3.3 V (+5 V tolerant)

Busless Operation

- Board can be supplied with +5 V only, all other voltages are generated on the board
- Backplane connectors used only for power supply

Electrical Specifications

- Supply voltage/power consumption with Celeron® M722 processor:
 - +5 V (-3%/+5%), 2.2 A typ., 2.7 A max.
 - +3.3 V (-3%/+5%), 1.4 A (2 Gb Ethernet), 1 A (1 Gb Ethernet)
 - +12 V (-10%/+10%), approx. 10 mA
 - If the board is supplied with 5 V only (typically without a bus connection), the 3.3 V are generated on the board and fed to the backplane (3 A max.)
- Supply voltage/power consumption with SP9300 processor:
 - +5 V (-3%/+5%), 4.9 A typ., 6.4 A max.
 - +3.3 V (-3%/+5%), 1.4 A (2 Gb Ethernet), 1 A (1 Gb Ethernet)
 - +12 V (-10%/+10%), approx. 10 mA
 - If the board is supplied with 5 V only (typically without a bus connection), the 3.3 V are generated on the board and fed to the backplane (3 A max.)

Mechanical Specifications

- Dimensions: conforming to CompactPCI® specification for 3U boards
- Front panel: 4HP with ejector
- Weight: 430 g

Environmental Specifications

- Temperature range (operation):
 - Depends on system configuration (CPU, hard disk, heat sink...)
 - Maximum: +85°C
 - Minimum: -40°C (all processors)
 - Conditions: airflow 1.5 m/s, typical power dissipation: 9.8 W (F19P version with Celeron® M722), 13.4 W (F19P version with SP9300 Core 2 Duo) with Windows® XP operating system and 1 Gb Ethernet connection
- Temperature range (storage): -40..+85°C
- Relative humidity (operation): max. 95% non-condensing
- Relative humidity (storage): max. 95% non-condensing
- Altitude: -300 m to +2,000 m
- Shock: 50 m/s², 30 ms
- Vibration (function): 1 m/s², 5 Hz – 150 Hz
- Vibration (lifetime): 7.9 m/s², 5 Hz – 150 Hz
- Conformal coating on request

MTBF

- 552,030h @ 40°C according to IEC/TR 62380 (RDF2000)

Safety

- PCB manufactured with a flammability rating of 94V-0 by UL recognized manufacturers

EMC

- Tested according to EN 55022 (radio disturbance), IEC 61000-4-3 (electromagnetic field immunity), IEC 61000-4-4 (burst), IEC 61000-4-5 (surge) and IEC 61000-4-6 (conducted disturbances)

BIOS

- InsydeH2O™ UEFI Framework

Software Support

- Note that 64-bit hardware technology can be used in an optimal way with 64-bit operating system support
- Windows® (Windows® XP, Windows® 7)
- Linux
 - tested/verified with: Ubuntu 10.04 (kernel 2.6.32-21) 32-bit and 64-bit versions
 - OpenSuse 11.3 32-bit and 64-bit versions
 - and: CentOS 5.5 (kernel 2.6.18) 32-bit and 64-bit versions
 - Detailed matrix of supported interfaces under Ubuntu 10.04 and OpenSuse 11.3
- VxWorks®
- QNX®
- Intel® Virtualization Technology, allows a platform to run multiple operating systems and applications in independent partitions; one computer system can function as multiple virtual systems



For more information on supported operating system versions and drivers see [online data sheet](#).

Configuration Options

CPU

- Intel® SP9300, 2.26 GHz, 1066 MHz FSB, 6 MB cache, 25 W
- Intel® SL9400, 1.86 GHz, 1066 MHz FSB, 6 MB cache, 17 W
- Intel® SU9300, 1.2 GHz, 800 MHz FSB, 3 MB cache, 10 W
- Intel® Celeron® M722, 1.2 GHz, 800 MHz FSB, 1 MB cache, 5.5 W
- Intel® Celeron® M723, 1.2 GHz, 800 MHz FSB, 1 MB cache, 10 W

Memory

- System RAM
 - 2 GB or 4 GB
- CompactFlash®
 - 0 MB up to maximum available
- MicroSD card
 - 0 MB up to maximum available
- NAND Flash instead of CompactFlash®, microSD™ card and battery
 - 0 MB up to maximum available

Graphics

- One or two DVI-D connectors at front via side card
 - Simultaneous connection of two monitors

I/O

- Ethernet
 - 9-pin D-Sub connector with one or two 10/100Base-T ports instead of two RJ45 connectors
 - Two M12 connectors with two 10/100/1000Base-T ports on 8HP instead of two RJ45 connectors

Mechanical

- Side card can be added at left or right side of CPU
- Adapter board for two M12 Ethernet connectors can be added at left or right side of CPU

Operation Temperature

- Depends on system configuration (CPU, hard disk, heat sink...)
- Maximum: +85°C
- Minimum: -40°C (all processors)

Cooling Concept

- Also available with conduction cooling in MEN CCA frame

Please note that some of these options may only be available for large volumes.



For available standard configurations see the [F19P online data sheet](#).
Please [contact MEN's sales team](#) for further information.

Product Safety

Lithium Battery



This board contains a lithium battery. There is a danger of explosion if the battery is incorrectly replaced! For replacing the battery correctly see [Chapter 5 Maintenance on page 90](#).

Electrostatic Discharge (ESD)



Computer boards and components contain electrostatic sensitive devices. Electrostatic discharge (ESD) can damage components. To protect the board and other components against damage from static electricity, you should follow some precautions whenever you work on your computer.

- Power down and unplug your computer system when working on the inside.
- Hold components by the edges and try not to touch the IC chips, leads, or circuitry.
- Use a grounded wrist strap before handling computer components.
- Place components on a grounded antistatic pad or on the bag that came with the component whenever the components are separated from the system.

Store the board only in its original ESD-protected packaging. Retain the original packaging in case you need to return the board to MEN for repair.

About this Document

This user manual is intended only for system developers and integrators, it is not intended for end users.

It describes the hardware functions of the board, connection of peripheral devices and integration into a system. It also provides additional information for special applications and configurations of the board.

The manual does not include detailed information on individual components (data sheets etc.). A list of literature is given in the appendix.

History

Issue	Comments	Date
E1	First issue	2009-09-30
E2	General update, corrected MAC addresses and Ethernet LED behavior	2010-08-24
E3	Updated BIOS description (see Chapter 3 BIOS)	2011-03-04
E4	Added Chapter 1.6.2 Installing Windows XP or Windows 7 on USB Devices , modified Chapter 2.1 Power Supply , added M12 Ethernet option, structured Chapter 2.11 Ethernet Interfaces more logically	2011-09-19
E5	Deleted 1x4 PCIe link (not supported)	2012-01-25
E6	Cosmetics, corrected options, added RTC accuracy, reworked block diagram	2015-01-13

Conventions



This sign marks important notes or warnings concerning proper functionality of the product described in this document. You should read them in any case.

italics

Folder, file and function names are printed in *italics*.

bold

Bold type is used for emphasis.

monospace

A monospaced font type is used for hexadecimal numbers, listings, C function descriptions or wherever appropriate. Hexadecimal numbers are preceded by "0x".

comment

Comments embedded into coding examples are shown in green color.

hyperlink

Hyperlinks are printed in [blue color](#).



The globe will show you where [hyperlinks](#) lead directly to the Internet, so you can look for the latest information online.

IRQ#
/IRQ

Signal names followed by "#" or preceded by a slash ("/") indicate that this signal is either active low or that it becomes active at a falling edge.

in/out

Signal directions in signal mnemonics tables generally refer to the corresponding board or component, "in" meaning "to the board or component", "out" meaning "coming from it".



Vertical lines on the outer margin signal technical changes to the previous issue of the document.

Legal Information

Changes

MEN Mikro Elektronik GmbH ("MEN") reserves the right to make changes without further notice to any products herein.

Warranty, Guarantee, Liability

MEN makes no warranty, representation or guarantee of any kind regarding the suitability of its products for any particular purpose, nor does MEN assume any liability arising out of the application or use of any product or circuit, and specifically disclaims any and all liability, including, without limitation, consequential or incidental damages. TO THE EXTENT APPLICABLE, SPECIFICALLY EXCLUDED ARE ANY IMPLIED WARRANTIES ARISING BY OPERATION OF LAW, CUSTOM OR USAGE, INCLUDING WITHOUT LIMITATION, THE IMPLIED WARRANTIES OF MERCHANTABILITY AND FITNESS FOR A PARTICULAR PURPOSE OR USE. In no event shall MEN be liable for more than the contract price for the products in question. If buyer does not notify MEN in writing within the foregoing warranty period, MEN shall have no liability or obligation to buyer hereunder.

The publication is provided on the terms and understanding that:

1. MEN is not responsible for the results of any actions taken on the basis of information in the publication, nor for any error in or omission from the publication; and
2. MEN is not engaged in rendering technical or other advice or services.

MEN expressly disclaims all and any liability and responsibility to any person, whether a reader of the publication or not, in respect of anything, and of the consequences of anything, done or omitted to be done by any such person in reliance, whether wholly or partially, on the whole or any part of the contents of the publication.

Conditions for Use, Field of Application

The correct function of MEN products in mission-critical and life-critical applications is limited to the environmental specification given for each product in the technical user manual. The correct function of MEN products under extended environmental conditions is limited to the individual requirement specification and subsequent validation documents for each product for the applicable use case and has to be agreed upon in writing by MEN and the customer. Should the customer purchase or use MEN products for any unintended or unauthorized application, the customer shall indemnify and hold MEN and its officers, employees, subsidiaries, affiliates, and distributors harmless against all claims, costs, damages, and expenses, and reasonable attorney fees arising out of, directly or indirectly, any claim or personal injury or death associated with such unintended or unauthorized use, even if such claim alleges that MEN was negligent regarding the design or manufacture of the part. In no case is MEN liable for the correct function of the technical installation where MEN products are a part of.

Trademarks

All products or services mentioned in this publication are identified by the trademarks, service marks, or product names as designated by the companies which market those products. The trademarks and registered trademarks are held by the companies producing them. Inquiries concerning such trademarks should be made directly to those companies.

Conformity

MEN products are no ready-made products for end users. They are tested according to the standards given in the Technical Data and thus enable you to achieve certification of the product according to the standards applicable in your field of application.

RoHS

Since July 1, 2006 all MEN standard products comply with RoHS legislation.

Since January 2005 the SMD and manual soldering processes at MEN have already been completely lead-free. Between June 2004 and June 30, 2006 MEN's selected component suppliers have changed delivery to RoHS-compliant parts. During this period any change and status was traceable through the MEN ERP system and the boards gradually became RoHS-compliant.



WEEE Application

The WEEE directive does not apply to fixed industrial plants and tools. The compliance is the responsibility of the company which puts the product on the market, as defined in the directive; components and sub-assemblies are not subject to product compliance.

In other words: Since MEN does not deliver ready-made products to end users, the WEEE directive is not applicable for MEN. Users are nevertheless recommended to properly recycle all electronic boards which have passed their life cycle.

Nevertheless, MEN is registered as a manufacturer in Germany. The registration number can be provided on request.

Copyright © 2014 MEN Mikro Elektronik GmbH. All rights reserved.

Germany

MEN Mikro Elektronik GmbH
Neuwieder Straße 3-7
90411 Nuremberg
Phone +49-911-99 33 5-0
Fax +49-911-99 33 5-901
E-mail info@men.de
www.men.de

France

MEN Mikro Elektronik SAS
18, rue René Cassin
ZA de la Châtelaine
74240 Gaillard
Phone +33 (0) 450-955-312
Fax +33 (0) 450-955-211
E-mail info@men-france.fr
www.men-france.fr

USA

MEN Micro Inc.
860 Penllyn Blue Bell Pike
Blue Bell, PA 19422
Phone (215) 542-9575
Fax (215) 542-9577
E-mail sales@menmicro.com
www.menmicro.com

Contents

1	Getting Started	19
1.1	Map of the Board	19
1.2	Configuring the Hardware	21
1.3	Integrating the Board into a System	22
1.4	Troubleshooting at Start-up	23
1.5	Configuring BIOS	23
1.6	Installing Operating System Software	23
1.6.1	Installing Windows 2000 via USB	23
1.6.2	Installing Windows XP or Windows 7 on USB Devices	23
1.7	Installing Driver Software	23
2	Functional Description	24
2.1	Power Supply	24
2.2	Board Supervision	25
2.3	Reset and Power-Off Behavior	26
2.4	Real-Time Clock	26
2.5	Processor Core	26
2.5.1	Thermal Considerations	27
2.6	Bus Structure	27
2.7	Memory	27
2.7.1	DRAM System Memory	27
2.7.2	Boot Flash	27
2.8	Mass Storage	28
2.8.1	CompactFlash	28
2.8.2	MicroSD Card	29
2.8.3	Optional USB SSD	29
2.8.4	Serial ATA (SATA)	29
2.9	Graphics	30
2.9.1	Connection via VGA	30
2.9.2	Connection via SDVO	30
2.10	USB Interfaces	31
2.10.1	Front-Panel Connection	31
2.10.2	Side-Card Connection	31
2.10.3	Rear I/O Connection (CompactPCI PlusIO)	32
2.11	Ethernet Interfaces	33
2.11.1	Front-Panel Connection	34
2.11.2	Rear I/O Connection	35
2.12	High Definition (HD) Audio Interface	36
2.13	Side-Card Interface	36
2.13.1	Connection	37
2.13.2	Installing a Side Card	43
2.14	PCI Express	46

2.14.1	General	46
2.14.2	Implementation on F19P.....	46
2.15	CompactPCI Interface	47
2.15.1	General	47
2.15.2	CompactPCI PlusIO Rear I/O.....	47
2.16	Reset Button and Status LED	51
3	BIOS.....	52
3.1	Main.....	53
3.2	Advanced.....	55
3.3	Security	70
3.4	Power.....	72
3.5	Boot	78
3.6	Exit	81
3.6.1	Exit Saving Changes.....	81
3.6.2	Save Change Without Exit	81
3.6.3	Exit Discarding Changes.....	81
3.6.4	Load Optimal Defaults	81
3.6.5	Load Custom Defaults.....	82
3.6.6	Save Custom Defaults.....	82
3.6.7	Discard Changes	82
4	Organization of the Board	83
4.1	Memory Mappings	83
4.1.1	Processor View of the Memory Map.....	83
4.1.2	I/O Memory Map	84
4.2	PCI Devices.....	87
4.3	SMBus Devices	88
4.4	Interrupt Mapping	88
5	Maintenance	90
5.1	Lithium Battery	90
6	Appendix	91
6.1	Literature and Web Resources.....	91
6.1.1	CPU.....	91
6.1.2	IDE	91
6.1.3	SATA.....	91
6.1.4	USB.....	91
6.1.5	Ethernet.....	91
6.1.6	HD Audio	92
6.1.7	PCI Express.....	92
6.1.8	CompactPCI/PCI.....	92
6.1.9	CompactPCI PlusIO	92
6.2	Finding out the Board's Article Number, Revision and Serial Number.....	93

Figures

Figure 1. Map of the board – front view	19
Figure 2. Map of the board – top view.....	20
Figure 3. Position of battery on the CompactFlash adapter on the F19P.....	90
Figure 4. Labels giving the board’s article number, revision and serial number	93

Tables

Table 1.	Processor core options on F19P	26
Table 2.	Pin assignment of 15-pin HD-Sub VGA receptacle connector	30
Table 3.	Signal mnemonics of 15-pin HD-Sub VGA connector	30
Table 4.	Pin assignment of USB front-panel connectors	31
Table 5.	Signal mnemonics of USB front-panel connectors	31
Table 6.	Signal mnemonics of Ethernet 10/100/1000Base-T connectors.....	34
Table 7.	Pin assignment and status LEDs of 8-pin RJ45 Ethernet 10/100/1000Base-T connectors (LAN1/LAN2).....	34
Table 8.	Pin assignment of 9-pin D-Sub 10Base-T/100Base-TX plug connector (LAN1/LAN2).....	35
Table 9.	Pin assignment of 114-pin side-card connector, pins 1..38	37
Table 10.	Pin assignment of 114-pin side-card connector, pins 39..76	38
Table 11.	Pin assignment of 114-pin side-card connector, pins 77..114	39
Table 12.	Signal mnemonics of 114-pin side-card connector	40
Table 13.	Pin assignment of CompactPCI connector J2.....	48
Table 14.	Signal mnemonics of CompactPCI connector J2 – CompactPCI and CompactPCI PlusIO rear I/O.....	49
Table 15.	Error codes signaled by board management controller via LED flashes	51
Table 16.	Memory map – processor view	83
Table 17.	Memory map - I/O	84
Table 18.	PCI Devices	87
Table 19.	SMBus devices.....	88
Table 20.	Interrupt Mapping.....	88

1 Getting Started

This chapter gives an overview of the board and some hints for first installation in a system.

1.1 Map of the Board

Figure 1. Map of the board – front view

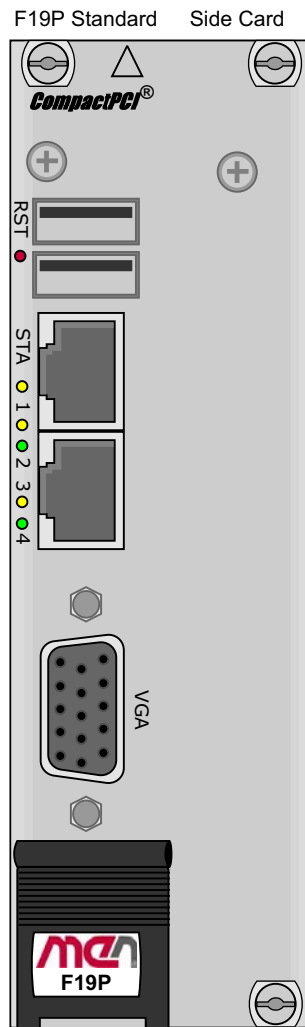
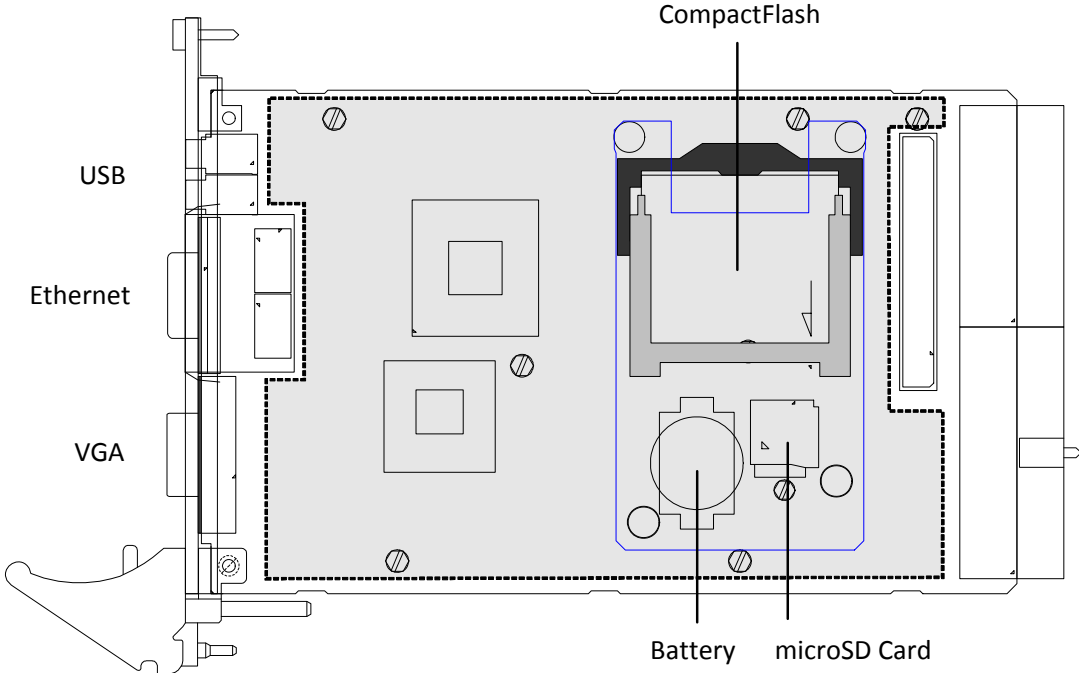

Figure 2. Map of the board – top view



1.2 Configuring the Hardware

You should check your hardware requirements before installing the board in a system, since most modifications are difficult or even impossible to do when the board is mounted in a system.

The following check list gives an overview on what you might want to configure.

CompactFlash

The board is shipped without a CompactFlash card. You should check your needs and install a suitable CompactFlash card.

Refer to [Chapter 2.8.1.1 Inserting and Extracting a CompactFlash Card on page 28](#) for details on the IDE interface.

microSD

The board is shipped without a microSD card. You should check your needs and install a suitable microSD card.

Refer to [Chapter 2.8.2 MicroSD Card on page 29](#)

Expansion by a side card

The board offers the option of adding one side card. Side cards come in standard 3U format and can be attached directly to F19P at the heat sink side. Every side card has dedicated functions, e.g. legacy COM interfaces, SATA hard disk or DVI front connectors.

See [Chapter 2.13 Side-Card Interface on page 36](#) for details on side cards.



The MEN sales staff will be glad to help you find the right extension and front panel solution. See also [MEN's website](#) for ordering information and standard products.

1.3 Integrating the Board into a System

You can use the following check list when installing the F19P in a system for the first time and with minimum configuration.

- Power-down the system.
- Remove all boards from the CompactPCI system.
- Insert the F19P into the system slot of your CompactPCI system, making sure that the CompactPCI connectors are properly aligned.

Note: The system slot of every CompactPCI system is marked by a \triangle triangle on the backplane and/or at the front panel. It also has red guide rails.

- Connect a USB keyboard and mouse to the USB connectors at the front panel.
- Connect a CRT or flat-panel display to the VGA connector at the front panel.
- Power-up the system.
- You can start up the BIOS setup menu by hitting the <F2> key.
- Now you can make configurations in BIOS.

For more information on the BIOS see [Chapter 3 BIOS on page 52](#).

- Observe the installation instructions for the respective software.

1.4 Troubleshooting at Start-up

If you have any problems at start-up of the F19P, you can start the board with EFI default settings for troubleshooting.

For more information on the BIOS see [Chapter 3 BIOS on page 52](#).

1.5 Configuring BIOS

The F19P is equipped with an InsydeH2O UEFI framework. Normally you won't need to make any changes in the BIOS setup.

For more information on the BIOS see [Chapter 3 BIOS on page 52](#).

1.6 Installing Operating System Software

The board supports Windows, Linux, VxWorks and QNX.



By standard, no operating system is installed on the board. Please refer to the respective manufacturer's documentation on how to install operating system software!

1.6.1 Installing Windows 2000 via USB

If you want to install Windows 2000 using a USB CD-ROM drive, you must install from a Windows 2000 CD including Service Pack 4 to avoid problems. This is a known Windows problem.

1.6.2 Installing Windows XP or Windows 7 on USB Devices

The CompactFlash and the microSD card of the F19P are connected via USB. A standard Windows operating system (like Windows XP Professional or Windows 7 Ultimate) does not support direct installation on USB memory devices.

There are two possible solutions:

- Add a hard drive (SATA, mSATA) on a peripheral board or side card
- Switch to an Embedded Windows (like Windows Embedded Standard or Windows Embedded Standard 7). These Embedded Windows operating systems support being installed on and booted from a USB device.

Linux supports booting from a USB device without problems.

1.7 Installing Driver Software

For a detailed description on how to install driver software please refer to the respective documentation.



You can find any driver software and documentation for the F19P available for download on MEN's [website](#).

2 Functional Description

The following describes the individual functions of the board and their configuration on the board. There is no detailed description of the individual controller chips and the CPU. They can be obtained from the data sheets or data books of the semiconductor manufacturer concerned.

For more information, see [Chapter 6.1 Literature and Web Resources on page 91](#).

2.1 Power Supply

There are only two possible ways to power the F19P:

- +5V, +3.3V **and** +12V via CompactPCI connector J1
- +5V **only** via CompactPCI connector J1



To supply the board with 3.3V and 5V is not allowed and may cause serious damage. If +3.3V are supplied via CompactPCI connector J1, the +12V supply always has to be present.

If the +12V are not present, the board automatically generates +3.3V and also feeds them to the backplane, which would cause a conflict with the external +3.3V supply.

2.2 Board Supervision

The F19P provides an intelligent board management controller (BMC) with the following main features:

- Board power sequencing control
- Voltage supervision
- System watchdog
- Software reset functionality
- Error state logging
- Power mode settings
- SMBus communication with main CPU

The watchdog device monitors the board on operating system level. If enabled, the watchdog must be triggered by application software. If the trigger is overdue, the watchdog initiates a board reset and this way can put the system back into operation when the software hangs.

The watchdog uses a configurable time interval or is disabled. Settings are made through BIOS or via an MEN software driver.

In addition, the F19P uses a National LM95245 device to measure the CPU die temperature and the local board temperature.

MEN provides dedicated software drivers for the board controller and LM95245 device. For a detailed description of the functionality of the driver software please refer to the drivers' documentation.



You can find any driver software and documentation available for download on MEN's [website](#).

2.3 Reset and Power-Off Behavior

The F19P generates its own reset signal. You can wake it up from reset state by externally switching the power supply off and on.

The CompactPCI *PBRST#* signal and the recessed button at the front panel generate a board reset signal.

See also [Chapter 2.16 Reset Button and Status LED on page 51](#).

2.4 Real-Time Clock

The board includes a real-time clock connected to the Southbridge. For data retention during power off the RTC is backed up by a GoldCap capacitor. The GoldCap gives an autonomy of approx. 14 hours when fully loaded. Under normal conditions, replacement should be superfluous during lifetime of the board. The RTC can generate interrupt requests to the Southbridge.

The RTC has an accuracy of approximately 1.7 seconds/day (11 minutes/year) at 25°C.

For retention of time/date data after a power off of more than 8-10 hours the RTC is also backed by a battery.



For ordering options please see MEN's [website](#)

2.5 Processor Core

The F19P can be equipped with different types of Intel Core 2 Duo or Celeron processors. The following table gives a performance overview:

Table 1. Processor core options on F19P

Processor Type	Core Frequency	Power Class	L2 Cache	Front Side Bus
Intel Core 2 Duo SP9300	2.26 GHz	25 W	6 MB	1066 MHz
Intel Core 2 Duo SL9400	1.86 GHz	17W	6 MB	1066 MHz
Intel Core 2 Duo SU9300	1.2 GHz	10 W	3 MB	800 MHz
Intel Celeron M722	1.2GHz	5.5 W	1 MB	800 MHz
Intel Celeron M723	1.2 GHz	10 W	1 MB	800 MHz

2.5.1 Thermal Considerations

A suitable heat sink is provided to meet thermal requirements. For special requirements a larger heat sink is also available on request.



Please note that if you use any other heat sink than that supplied by MEN, or no heat sink at all, warranty on functionality and reliability of the F19P may cease. If you have any questions or problems regarding thermal behavior, please contact [MEN sales](#) for more information.

2.6 Bus Structure

The F19P uses an Intel GS45 component as the Northbridge¹ that connects to the processor core and controls memory and graphics, and an Intel ICH9M-SFF I/O Controller Hub as the Southbridge². Any I/O is directly controlled by this chip set, there is no local PCI bus.

The CompactPCI bus connects directly to the Southbridge.

2.7 Memory

The standard board versions provide a memory configuration suitable for many applications. However, memory on the F19P can also be configured for your needs.



For standard memory sizes and ordering options please see [MEN's website](#).

2.7.1 DRAM System Memory

The board provides up to 4 GB onboard, soldered DDR3 (double data rate) SDRAM. The memory bus is 2x64 bits wide (dual channel) and operates with up to 1067 MHz.

2.7.2 Boot Flash

The F19P has an 16-Mbit SPI Serial Flash implemented as onboard Flash for BIOS data.

¹ The Northbridge is the component of the chip set that is located closely to the CPU, for fast data transfer.

² The Southbridge is the component of the chip set that connects to PCI devices and controls data exchange with peripherals and other interfaces.

2.8 Mass Storage

The F19P offers the possibility to connect a CompactFlash and a microSD card on a small adapter card in the heat sink area which is assembled by standard.

The slots are controlled via one USB port from the chipset.

2.8.1 CompactFlash

Even with CompactFlash the board needs only one slot in the system.



Please see [MEN's website](#) for ordering options.

2.8.1.1 Inserting and Extracting a CompactFlash Card

The F19P supports standard CompactFlash cards. .



For CompactFlash cards available from MEN see [MEN's website](#)

The F19P is shipped without a CompactFlash card installed. To install CompactFlash, please stick to the following procedure.

- Power down your system and remove the F19P from the system.
- Put the board on a flat surface.
- Lift the CompactFlash holding bracket.

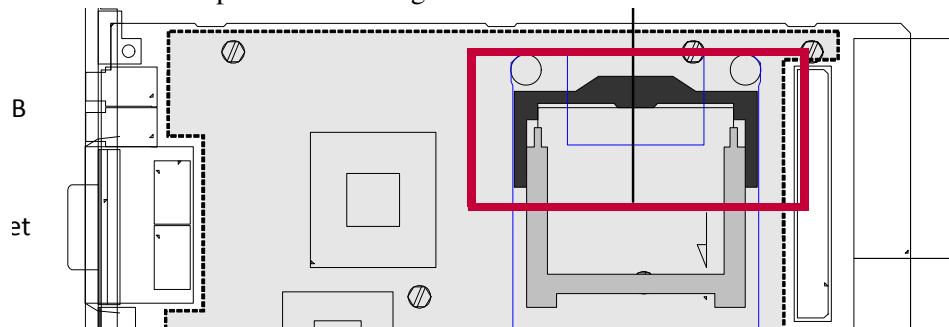

- Insert the CompactFlash card carefully as indicated by the arrow on top of the card.
- Make sure that all the contacts are aligned properly and the card is firmly connected with the card connector.
- Push the CompactFlash holding bracket back down until it clicks into place.
- Observe manufacturer notes on usage of CompactFlash cards.

2.8.2 MicroSD Card

The F19P provides an onboard microSD slot beside the CompactFlash on a small adapter card in the heat sink area. The slot is ready-to-use.

Even with a microSD card the board needs only one slot in the system.



Please see [MEN's website](#) for ordering options.

2.8.3 Optional USB SSD

As an option, a USB based solid state drive instead of the CompactFlash and the microSD card can be used.

2.8.4 Serial ATA (SATA)

The serial ATA (SATA) interface is controlled by the Southbridge and provides four SATA channels.

In compliance with the CompactPCI PlusIO standard (PICMG 2.30) these interfaces are led to the J2 rear I/O connector.

As an option it is also possible to lead one SATA channel to the side-card connector. The device can be connected through the use of a side card. In this case only three SATA channels are available via the J2 connector.

This SATA port can be switched to side-card port A or B. The SATA routing can be controlled by BIOS settings. See [Chapter 3 BIOS on page 52](#). The interface is compliant with SATA Revision 2.x and supports transfer rates of 3.0 Gbits/s.

The interface is able to run in AHCI and RAID 0 and 1 mode..

Please see [Chapter 2.13 Side-Card Interface on page 36](#) for more details on the side-card interface and [Chapter 2.15.2 CompactPCI PlusIO Rear I/O on page 47](#) regarding the rear I/O.



Please see the [MEN website](#) for available side cards and for different versions of the F19P.

2.9 Graphics

The graphics subsystem is part of the Intel GS45 Express Northbridge and supports the following features:

- Up to 533 MHz graphics core
- Resolutions up to QXGA

2.9.1 Connection via VGA

You can connect a VGA monitor directly at the F19P's front panel. The pinout of the 15-pin HD-Sub connector is standard VGA.

Connector types:

- 15-pin HD-Sub receptacle according to DIN41652/MIL-C-24308, with thread bolt UNC 4-40
- Mating connector:
15-pin HD-Sub plug according to DIN41652/MIL-C-24308, available for ribbon cable (insulation piercing connection), hand-soldering connection or crimp connection

Table 2. Pin assignment of 15-pin HD-Sub VGA receptacle connector

	15	SCL	10	GND	5	GND
	14	VSYNC	9	-	4	-
	13	HSYNC	8	GND	3	B
	12	SDA	7	GND	2	G
	11	-	6	GND	1	R

Table 3. Signal mnemonics of 15-pin HD-Sub VGA connector

Signal	Direction	Function
GND	-	Ground
HSYNC	out	Horizontal synchronization
R, G, B	out	Analog monitor interface (red, green, blue)
SCL	out	Monitor I ² C interface
SDA	in/out	
VSYNC	out	Vertical synchronization

2.9.2 Connection via SDVO

The F19P also supports digital panels. Two SDVO ports are available through the side-card connector. MEN offers a side card with two additional DVI-D connectors at the front panel. This allows simultaneous connection of two monitors with two different images.

Please see [Chapter 2.13 Side-Card Interface on page 36](#) for further details on the side-card interface.



See MEN's [website](#) for available side cards.

2.10 USB Interfaces

The F19P provides twelve USB 2.0 ports controlled by the Southbridge. Two USB interfaces are routed to standard front-panel connectors, four are led to the side-card connector, and another four can be accessed on the CompactPCI J2 rear I/O connector (compliant to the CompactPCI PlusIO standard). One of the remaining two interfaces is used for connection of the CompactFlash and the microSD card. One interface is not used.

The USB interfaces support UHCI.

2.10.1 Front-Panel Connection

Two USB interfaces are accessible at the front panel.

Connector types:

- 4-pin USB Series A receptacle according to Universal Serial Bus Specification Revision 1.0
- Mating connector:
4-pin USB Series A plug according to Universal Serial Bus Specification Revision 1.0

Table 4. Pin assignment of USB front-panel connectors

	1	+5V
	2	USB_D-
	3	USB_D+
	4	GND

Table 5. Signal mnemonics of USB front-panel connectors

Signal	Direction	Function
+5V	out	+5 V power supply
GND	-	Digital ground
USB_D+, USB_D-	in/out	USB lines, differential pair

2.10.2 Side-Card Connection

Four USB interfaces are accessible via a side card.

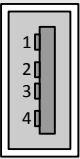
See [Chapter 2.13 Side-Card Interface on page 36](#) for details on the side-card interface.



See [MEN's website](#) for available side cards and board versions.

2.10.3 Rear I/O Connection (CompactPCI PlusIO)

Four USB interfaces are accessible via rear I/O in compliance to the CompactPCI PlusIO standard PICMG 2.30.

See [Chapter 2.15.2 CompactPCI PlusIO Rear I/O on page 47](#) for J2 rear I/O pin assignments.

2.11 Ethernet Interfaces

The F19P offers three Ethernet interfaces connected to the chipset via three x1 PCI Express (PCIe) links. The two interfaces available at the front are controlled by two Intel 82574L Ethernet controllers. The third interface is accessible via rear I/O and is controlled by the PCI Express graphics port from the graphics controller. The interfaces support 10 Mbits/s up to 1000 Mbits/s as well as full-duplex operation and autonegotiation.



The unique MAC address is set at the factory and should not be changed. Any attempt to change this address may create node or bus contention and thereby render the board inoperable.

The naming of the interfaces may differ depending on the operating system. The MAC addresses on F19P are:

- LAN1 (upper front interface):
- 0x 00 C0 3A 9D 8x xx - 0x 00 C0 3A 9D Bx xx
- LAN2 (lower front interface):
- 0x 00 C0 3A 9D Cx xx - 0x 00 C0 3A 9D Fx xx
- LAN3 (rear I/O) :
- 0x 00 C0 3A 9D 4x xx - 0x 00 C0 3A 9D 7x xx

where "00 C0 3A" is the MEN vendor code, "9D" is the MEN product code. The last four digits depend on the interface and the serial number of the product. The serial number is added to the offset, for example for LAN1:

Serial number 0042: 0x xx xx = 0x4000 + 0x002A = 0x 40 2A.

Also see [Chapter 6.2 Finding out the Board's Article Number, Revision and Serial Number on page 93](#).

2.11.1 Front-Panel Connection

Two standard RJ45 connectors are available at the front panel. There are two status LEDs for each channel at the front panel.

The pin assignment corresponds to the Ethernet specification IEEE802.3.

Table 6. Signal mnemonics of Ethernet 10/100/1000Base-T connectors

Signal	Direction	Function
BI_Dx+/-	in/out	Differential pairs of data lines for 1000Base-T
RX+/-	in	Differential pair of receive data lines for 10/100Base-T
TX+/-	out	Differential pair of transmit data lines for 10/100Base-T

2.11.1.1 Connection via RJ45 Connectors

Connector types:

- Modular 8/8-pin mounting jack according to FCC68
- Mating connector:
Modular 8/8-pin plug according to FCC68

Table 7. Pin assignment and status LEDs of 8-pin RJ45 Ethernet 10/100/1000Base-T connectors (LAN1/LAN2)

		1000Base-T	10/100Base-T	
Lights up when a link is established, and blinks whenever there is transmit or receive activity	1/3 ●	1	BI_DA+	TX+
		2	BI_DA-	TX-
		3	BI_DB+	RX+
		4	BI_DC+	-
On: Link 100Mbps/s Off: Link with 1 Gbits/s or 10Mbps/s	2/4 ●	5	BI_DC-	-
		6	BI_DB-	RX-
		7	BI_DD+	-
		8	BI_DD-	-

2.11.1.2 Connection via 9-pin D-Sub Connector (optional)



A D-Sub connector can be implemented as an option. In this case, no Gigabit Ethernet connection is supported, only 10Base-T and 100Base-TX. The two interfaces are routed to one D-Sub connector.

Connector types:

- 9-pin D-Sub plug according to DIN41652/MIL-C-24308, with thread bolt UNC 4-40
- Mating connector:
9-pin D-Sub receptacle according to DIN41652/MIL-C-24308, available for ribbon cable (insulation piercing connection), hand-soldering connection or crimp connection

Table 8. Pin assignment of 9-pin D-Sub 10Base-T/100Base-TX plug connector (LAN1/LAN2)

	1	LAN2_TX+	1	LAN2_TX+
	2	LAN1_TX+	2	LAN1_TX+
	3	-	3	-
	4	LAN1_RX+	4	LAN1_RX+
	5	LAN2_RX+	5	LAN2_RX+
	6	LAN2_TX-	6	LAN2_TX-
	7	LAN1_TX-	7	LAN1_TX-
	8	LAN1_RX-	8	LAN1_RX-
	9	LAN2_RX-	9	LAN2_RX-

2.11.1.3 Connection via two M12 Connectors (optional)

As an option, the two front Ethernet interfaces of the F19P can be implemented on two M12 connectors using an adapter board. The board takes a front panel space of 8HP in that case.



Please [contact MEN's sales team](#) for further information.

2.11.2 Rear I/O Connection

A third Ethernet interface is controlled via a PCI Express x1 link from the Northbridge (PCI Express graphics port) and available at the rear I/O connector J2 in compliance with the CompactPCI PlusIO standard PICMG 2.30.

For the J2 rear I/O pin assignments see [Chapter 2.15.2 CompactPCI PlusIO Rear I/O on page 47](#)

2.12 High Definition (HD) Audio Interface

The F19P provides an HD Audio interface accessible via a side card..

See [Chapter 2.13 Side-Card Interface on page 36](#) for details on the side-card interface and [Chapter 6.1 Literature and Web Resources on page 91](#) for literature on HD Audio.



Also see the [MEN website](#) for available side cards.

2.13 Side-Card Interface

MEN offers a number of side cards for F19P, featuring different I/O functionality. The side cards are all standard 3U Eurocards in 4 HP (single) width. Access to I/O connectors is given directly from the front panel.

The side-card connector is located at the top side of the board, so that one side card can be attached to the right side of the F19P. As an option, the F19P can also be supplied with the side-card connector at the bottom side, so that the side card may be attached to the left side of the CPU.

The side-card connector on F19P supports the following interfaces:

- One SATA channel (switchable)
- Four USB interfaces
- Up to four PCI Express x1 links
- HD audio interface
- Two SDVO serial digital video outputs



Neither the +3.3V nor the +5V pins of the expansion interface connector are protected against a short-circuit situation! This connector therefore should be used exclusively for attachment of a side card.



See the [MEN website](#) for available side cards and board versions.

2.13.1 Connection

Connector types:

- 114-pin matched impedance receptacle connector, MICTOR 0.64 mm grid
- Mating connector:
114-pin matched impedance plug connector, MICTOR 0.64 mm grid

Table 9. Pin assignment of 114-pin side-card connector, pins 1..38

1	2	1	GND	2	GND
		3	SATA_A_TX+	4	SATA_B_TX+
		5	SATA_A_TX-	6	SATA_B_TX-
		7	GND	8	GND
		9	SATA_A_RX+	10	SATA_B_RX+
		11	SATA_A_RX-	12	SATA_B_RX-
		13	GND	14	GND
		15	PCIE1_TX+	16	PCIE3_TX+
		17	PCIE1_TX-	18	PCIE3_TX-
		19	GND	20	GND
		21	PCIE1_RX+	22	PCIE3_RX+
		23	PCIE1_RX-	24	PCIE3_RX-
		25	GND	26	GND
		27	PCIE0_TX+	28	PCIE2_TX+
		29	PCIE0_TX-	30	PCIE2_TX-
		31	GND	32	GND
		33	PCIE0_RX+	34	PCIE2_RX+
		35	PCIE0_RX-	36	PCIE2_RX-
		37	GND	38	GND

Note: The SATA channel is not available if this channel is used for rear I/O. It can be switched to SATA_A or to SATA_B via BIOS settings..

The PCI Express lanes are only available if they are not used for rear I/O.

See [Chapter 2.8.4 Serial ATA \(SATA\)](#) on page 29 and [Chapter 3 BIOS](#) on page 52) on how to switch to SATA_A or to SATA_B via BIOS settings.

Table 10. Pin assignment of 114-pin side-card connector, pins 39..76

	39	+3.3V	+5V	40	+3.3V
	41	USB_2_3_OC#		42	HDA_SYNC
	43	USB_4_5_OC#		44	HDA_BIT_CLK
	45	GND		46	HDA_RST#
	47	USB_D3-		48	HDA_SDOUT
	49	USB_D3+		50	HDA_SDIN
	51	GND		52	GND
	53	USB_D2-		54	PCIE_WAKE#
	55	USB_D2+		56	PLT_RST#
	57	GND		58	LINKCAP
	59	USB_D5-		60	SMB_CLK
	61	USB_D5+		62	SMB_DATA
	63	GND		64	GND
	65	USB_D4-		66	SDVOCTRL_CLK
	67	USB_D4+		68	SDVOCTRL_DATA
	69	GND		70	GND
71	PCIE_CLK_A_REF+	72	PCIE_CLK_B_REF+		
73	PCIE_CLK_A_REF-	74	PCIE_CLK_B_REF-		
75	GND	76	GND		

Table 11. Pin assignment of 114-pin side-card connector, pins 77.114

	77	GND	GND	78	GND
	79	SDVO_TVCLKIN-		80	SDVO_FLDSTALL-
	81	SDVO_TVCLKIN+		82	SDVO_FLDSTALL+
	83	GND		84	GND
	85	SDVOB_BLUE-		86	SDVOC_BLUE-
	87	SDVOB_BLUE+		88	SDVOC_BLUE+
	89	GND		90	GND
	91	SDVOB_GREEN-		92	SDVOC_GREEN-
	93	SDVOB_GREEN+		94	SDVOC_GREEN+
	95	GND		96	GND
	97	SDVOB_RED-		98	SDVOC_RED-
	99	SDVOB_RED+		100	SDVOC_RED+
	101	GND		102	GND
	103	SDVOB_CLK-		104	SDVOC_CLK-
105	SDVOB_CLK+	106	SDVOC_CLK+		
107	GND	108	GND		
109	SDVOB_INT-	110	SDVOC_INT-		
111	SDVOB_INT+	112	SDVOC_INT+		
113	GND	114	GND		

Table 12. Signal mnemonics of 114-pin side-card connector

	Signal	Direction	Function
Power	+3.3V	out	+3.3 V power supply
	+5V	out	+5 V power supply
	GND	-	Digital ground of respective interface
SATA (one port which can be switched to SATA_A or SATA_B)	SATA_A_RX+, SATA_A_RX-	in	Differential pair of SATA receive lines, port A (not available if used for rear I/O)
	SATA_A_TX+, SATA_A_TX-	out	Differential pair of SATA transmit lines, port A (not available if used for rear I/O)
	SATA_B_RX+, SATA_B_RX-	in	Differential pair of SATA receive lines, port B (not available if used for rear I/O)
	SATA_B_TX+, SATA_B_TX-	out	Differential pair of SATA transmit lines, port B (not available if used for rear I/O)
PCI Express (not available if used for rear I/O)	PCIE_CLK_A_REF+, PCIE_CLK_A_REF-	out	Reference clock A 100 MHz
	PCIE_CLK_B_REF+, PCIE_CLK_B_REF-	out	Reference clock B 100 MHz
	PCIE0_RX+, PCIE0_RX-	in	Differential pair of PCIe receive lines, port 0
	PCIE0_TX+, PCIE0_TX-	out	Differential pair of PCIe transmit lines, port 0
	PCIE1_RX+, PCIE1_RX-	in	Differential pair of PCIe receive lines, port 1
	PCIE1_TX+, PCIE1_TX-	out	Differential pair of PCIe transmit lines, port 1
	PCIE2_RX+, PCIE2_RX-	in	Differential pair of PCIe receive lines, port 2
	PCIE2_TX+, PCIE2_TX-	out	Differential pair of PCIe transmit lines, port 2
	PCIE3_RX+, PCIE3_RX-	in	Differential pair of PCIe receive lines, port 3
	PCIE3_TX+, PCIE3_TX-	out	Differential pair of PCIe transmit lines, port 3
	PCIE_WAKE#	in	Wake signal from PCIe device to wake F19P from sleep state

	Signal	Direction	Function
USB	USB_D[2]+, USB_D[2]-	in/out	Differential pair of USB lines, port 2
	USB_D[3]+, USB_D[3]-	in/out	Differential pair of USB lines, port 3
	USB_D[4]+, USB_D[4]-	in/out	Differential pair of USB lines, port 4
	USB_D[5]+, USB_D[5]-	in/out	Differential pair of USB lines, port 5
	USB_OC23#	in	USB overcurrent, ports 2 and 3
	USB_OC45#	in	USB overcurrent, ports 4 and 5
HD Audio	HDA_BIT_CLK	in/out	HD Audio serial data clock
	HDA_RST#	out	HD Audio reset
	HDA_SDIN	in	HD Audio serial data in
	HDA_SDOOUT	out	HD Audio serial data out
	HDA_SYNC	out	HD Audio synchronization
Serial Digital Video Output (SDVO)	SDVOB_BLUE+, SDVOB_BLUE-	out	Serial digital video B blue data, differential pair
	SDVOB_GREEN+, SDVOB_GREEN-	out	Serial digital video B green data, differential pair
	SDVOB_RED+, SDVOB_RED-	out	Serial digital video B red data, differential pair
	SDVOB_CLK+, SDVOB_CLK-	out	Serial digital video B clock, differential pair
	SDVOB_INT+, SDVOB_INT-	in	Serial digital video B input interrupt, differential pair
	SDVOC_BLUE+, SDVOC_BLUE-	out	Serial digital video C blue data, differential pair
	SDVOC_GREEN+, SDVOC_GREEN-	out	Serial digital video C green data, differential pair
	SDVOC_RED+, SDVOC_RED-	out	Serial digital video C red data, differential pair
	SDVOC_CLK+, SDVOC_CLK-	out	Serial digital video C clock, differential pair
	SDVOC_INT+, SDVOC_INT-	in	Serial digital video C input interrupt, differential pair
	SDVO_FLDSTALL+, SDVO_FLDSTALL-	in	Serial digital video field stall, differential pair
	SDVO_TVCLKIN+, SDVO_TVCLKIN-	in	Serial digital video TVOUT synchronization clock, differential pair
	SDVOCTRL_CLK	in/out	I2C based control signal (clock) for SDVO device
	SDVOCTRL_DATA	in/out	I2C based control signal (data) for SDVO device

	Signal	Direction	Function
Other	LINKCAP	in	LINKCAP indicates how the CompactPCI Express backplane system slot is routed (2-Link combined or 4-Link configuration).
	PLT_RST#	out	Platform reset (global reset)
	SMB_CLK	out	System Management Bus clock
	SMB_DATA	in/out	System Management Bus data

2.13.2 Installing a Side Card

Perform the following steps to install a side card:

- ☑ Power-down your system and remove the F19P from the system.
- ☑ Remove the front panel: Loosen and remove the screws highlighted in red.

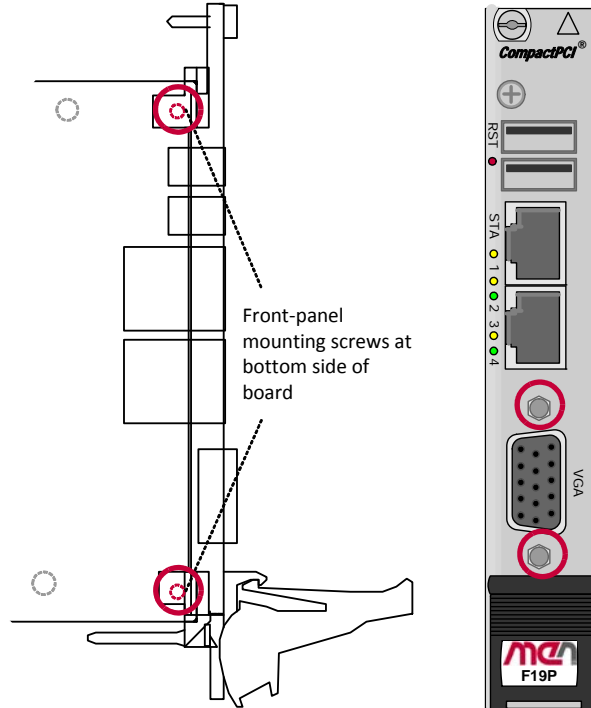

- ☑ Remove the front-panel ejector from the F19P front panel: Loosen the ejector screw at the back of the front panel.
- ☑ Install the ejector on the side card's front panel.

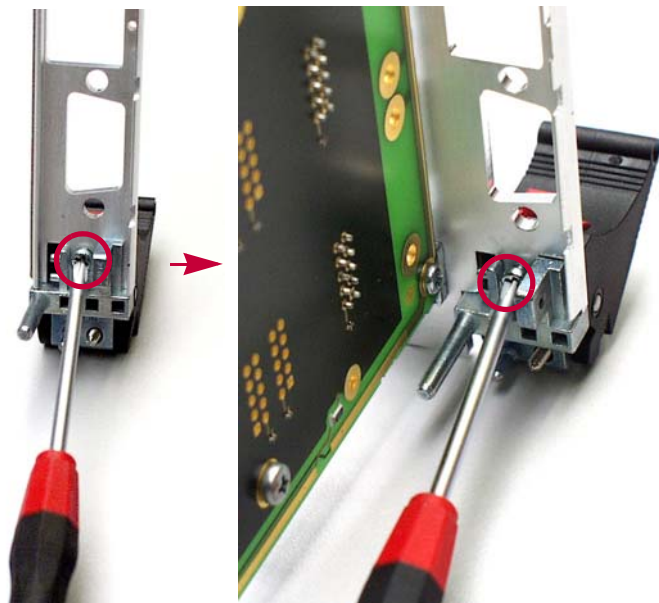

- ☑ Install the side card standoff supplied with the side card in the mounting hole indicated in red in the following picture.
Note that two different standoffs are supplied with the side card. For the F19P the shorter standoff (M2x12 I/A) is required.

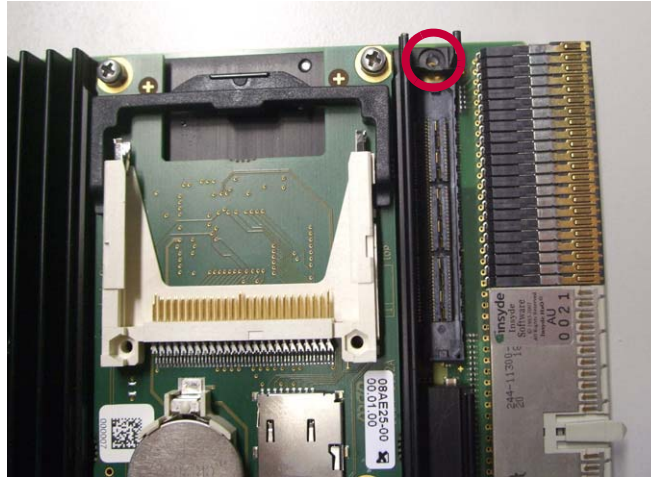

- ☑ Each side card comes with a dedicated one-piece, two-slot front panel. Align the F19P's front panel connectors with the side card's front panel, and align the board-to-board connector of the side card with the side-card connector of F19P. Press the board-to-board connectors together.

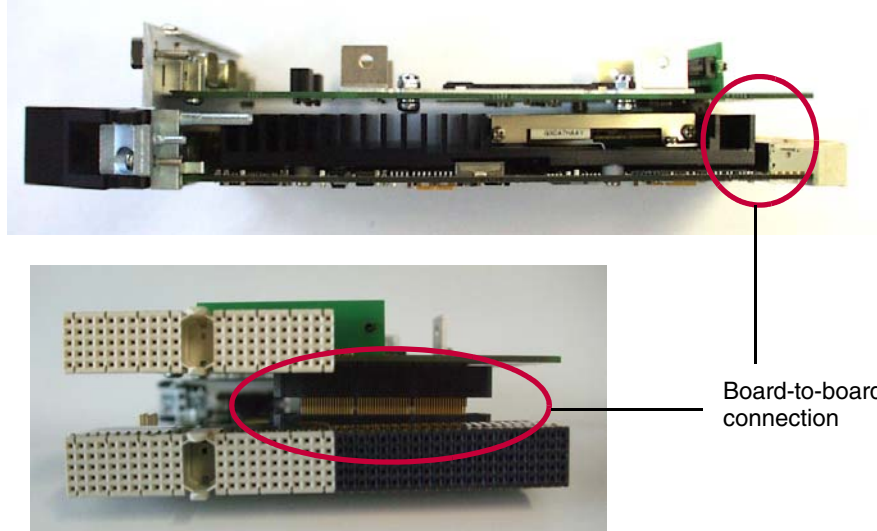

- ☑ Fasten the front panel: Install the screws removed before as highlighted in red.

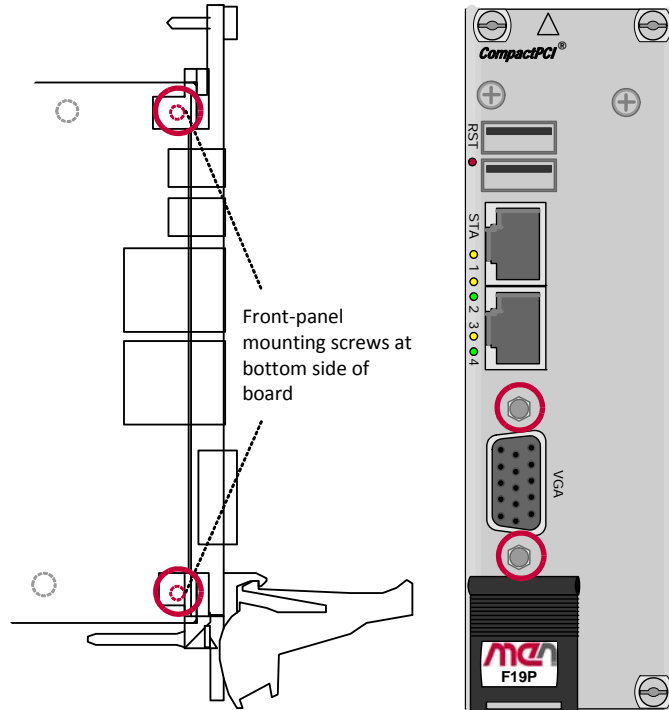

- ☑ Fasten the side-card standoff using the spring and screw provided with the side card at the top of the side card.



- ☑ Reinsert the board into your system.

2.14 PCI Express

2.14.1 General

PCI Express (PCIe) succeeds PCI and AGP and offers higher data transfer rates.

As opposed to the PCI bus, PCIe is no parallel bus but a serial point-to-point connection. Data is transferred using so-called lanes, with each lane consisting of a line pair for transmission and a second pair for reception. Individual components are connected using switches.

PCIe supports full-duplex operation and uses a clock rate of 1.25 GHz DDR. This results in a data rate of max. 250 MB/s per lane in each direction. (The standard PCI bus with 32 bits/33 MHz only allows a maximum of 133 MB/s.)

If you use only one lane, you speak of a PCIe x1 link. You can couple several lanes to increase the data rate, e.g. x2 with 2 lanes up to a x32 link using 32 lanes.

In addition, PCIe supports hot plug, for instance to exchange defect expansion boards during operation.

In terms of software, most operating systems can handle PCI Express boards just as well as the old PCI.

2.14.2 Implementation on F19P

On F19P the two Gigabit Ethernet channels are permanently connected via two PCIe x1 links. Another four x1 links are available for use over a side card. This means that the side card implementation determines the usage of these four links.

Alternatively, these four interfaces can be led to the J2 rear I/O connector in compliance with the CompactPCI PlusIO standard PICMG 2.30.

The Northbridge of the F19P provides an additional PCI Express link over the PEG (PCI Express Graphics) port. This link is used to connect the rear I/O Gigabit Ethernet interface.

2.15 CompactPCI Interface

2.15.1 General

The F19P is a 3U CompactPCI system slot board. It implements a 32-bit PCI interface to the CompactPCI backplane which uses a +3.3 V signaling voltage. It also tolerates +5 V.

The CompactPCI bus connects directly to the Southbridge. The board supports seven external PCI bus masters.

In combination with a specific side card the F19P can also perform system-slot functionality in a CompactPCI Express system.

2.15.2 CompactPCI PlusIO Rear I/O

The F19P is also compliant to the CompactPCI PlusIO standard PICMG 2.30. This means that it offers a fixed pin assignment of 1 Gigabit Ethernet, 4 SATA, 4 PCI Express and 4 USB interfaces at the J2 connector.

As a result, the pin assignment of the F19P rear I/O connector J2 is not compliant anymore to the rear I/O of the F14, F15, F17 and F18.

If you use four PCI Express x1 links via the J2 connector, no PCI Express is available via the side-card connector.

MEN offers a rear I/O transition module on which all interfaces from the J2 connector can be accessed, the CT12.



See [MEN's website](#) for further information.

The pin assignment of connector J1 as defined in the CompactPCI specification will not be repeated here. The table below shows the fixed pinout of the J2 connector.

Note: The F19P supports one Gigabit Ethernet interface at the rear whereas the PICMG 2.30 CompactPCI PlusIO standard supports up to two.

Table 13. Pin assignment of CompactPCI connector J2

	F	E	D	C	B	A	Z
22	GND	-	GA1	GA2	GA3	GA4	GND
21	GND	1_ETH_B+	1_ETH_D+	-	GND	CLK6	GND
20	GND	1_ETH_B-	1_ETH_D-	-	GND	CLK5	GND
19	GND	1_ETH_A+	1_ETH_C+	-	GND	GND	GND
18	GND	1_ETH_A-	1_ETH_C-	-	-	-	GND
17	GND	GNT6#	REQ6#	PBRST#	-	-	GND
16	GND	-	GND	DEG#	2_PE_CLK+	4_PE_CLK-	GND
15	GND	GNT5#	REQ5#	FAIL#	2_PE_CLK-	4_PE_CLK+	GND
14	GND	C_PWRBTN	SATA_SCL	4_PE_CLKE#	1_PE_CLK+	3_PE_CLK-	GND
13	GND	SATA_SL	SATA_SDO	3_PE_CLKE#	1_PE_CLK-	3_PE_CLK+	GND
12	GND	4_SATA_Rx+	SATA_SDI	2_PE_CLKE#	1_PE_CLKE#	4_PE_Rx00+	GND
11	GND	4_SATA_Rx-	4_SATA_Tx+	9_USB2+	4_PE_Tx00+	4_PE_Rx00-	GND
10	GND	3_SATA_Rx+	4_SATA_Tx-	9_USB2-	4_PE_Tx00-	3_PE_Rx00+	GND
9	GND	3_SATA_Rx-	3_SATA_Tx+	8_USB2+	3_PE_Tx00+	3_PE_Rx00-	GND
8	GND	2_SATA_Rx+	3_SATA_Tx-	8_USB2-	3_PE_Tx00-	2_PE_Rx00+	GND
7	GND	2_SATA_Rx-	2_SATA_Tx+	7_USB2+	2_PE_Tx00+	2_PE_Rx00-	GND
6	GND	1_SATA_Rx+	2_SATA_Tx-	7_USB2-	2_PE_Tx00-	1_PE_Rx00+	GND
5	GND	1_SATA_Rx-	1_SATA_Tx+	6_USB2+	1_PE_Tx00+	1_PE_Rx00-	GND
4	GND	-	1_SATA_Tx-	6_USB2-	1_PE_Tx00-	-	GND
3	GND	GNT4#	REQ4#	GNT3#	GND	CLK4	GND
2	GND	REQ3#	GNT2#	-	CLK3	CLK2	GND
1	GND	REQ2#	GNT1#	REQ1#	GND	CLK1	GND

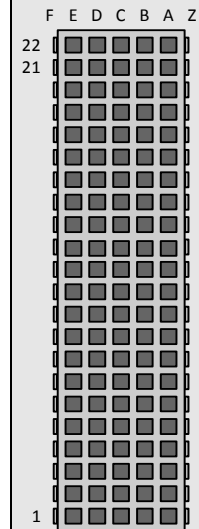

Table 14. Signal mnemonics of CompactPCI connector J2 – CompactPCI and CompactPCI PlusIO rear I/O

	Signal	Direction	Function
CompactPCI	CLK[6:1]	out	Clocks 1 to 6
	PBRST#	in	Push button reset
	DEG#	in	Power supply degenerate
	FAIL#	in	Power supply fail
	C_PWRBTN#	in	Power button, optional
	REQ#/GNT#[6:1]	in/out	Request/grant pairs 1 to 6
Ethernet	1_ETH_A+, 1_ETH_A-	in/out	Differential data pair 0, Ethernet port 1
	1_ETH_B+, 1_ETH_B-	in/out	Differential data pair 1, Ethernet port 1
	1_ETH_C+, 1_ETH_C-	in/out	Differential data pair 2, Ethernet port 1
	1_ETH_D+, 1_ETH_D-	in/out	Differential data pair 3, Ethernet port 1
SATA	1_SATA_Rx+, 1_SATA_Rx-	in	Differential pair of SATA receive lines, port 1
	1_SATA_Tx+, 1_SATA_Tx-	out	Differential pair of SATA transmit lines, port 1
	2_SATA_Rx+, 2_SATA_Rx-	in	Differential pair of SATA receive lines, port 2
	2_SATA_Tx+, 2_SATA_Tx-	out	Differential pair of SATA transmit lines, port 2
	3_SATA_Rx+, 3_SATA_Rx-	in	Differential pair of SATA receive lines, port 3
	3_SATA_Tx+, 3_SATA_Tx-	out	Differential pair of SATA transmit lines, port 3
	4_SATA_Rx+, 4_SATA_Rx-	in	Differential pair of SATA receive lines, port 4
	4_SATA_Tx+, 4_SATA_Tx-	out	Differential pair of SATA transmit lines, port 4
SGPIO	SATA_SC	out	Clock signal
	SATA_SL	out	Last clock of a bit stream; begin a new bit stream on the next clock
	SATA_SDO	out	Serial data output bit stream
	SATA_SDI	in	Serial data input bit stream (may not be supported by all SGPIO devices)

	Signal	Direction	Function
USB	6_USB2+, 6_USB2-	in/out	Differential pair of USB lines, port 6
	7_USB2+, 7_USB2-	in/out	Differential pair of USB lines, port 7
	8_USB2+, 8_USB2-	in/out	Differential pair of USB lines, port 8
	9_USB2+, 9_USB2-	in/out	Differential pair of USB lines, port 9
PCI Express	1_PE_Rx00+, 1_PE_Rx00-	in	Differential PCIe receive lines, lane 1
	1_PE_Tx00+, 1_PE_Tx00-	out	Differential PCIe transmit lines, lane 1
	2_PE_Rx00+, 2_PE_Rx00-	in	Differential PCIe receive lines, lane 2
	2_PE_Tx00+, 2_PE_Tx00-	out	Differential PCIe transmit lines, lane 2
	3_PE_Rx00+, 3_PE_Rx00-	in	Differential PCIe receive lines, lane 3
	3_PE_Tx00+, 3_PE_Tx00-	out	Differential PCIe transmit lines, lane 3
	4_PE_Rx00+, 4_PE_Rx00-	in	Differential PCIe receive lines, lane 4
	4_PE_Tx00+, 4_PE_Tx00-	out	Differential PCIe transmit lines, lane 4
	[1.4]_PE_CLKE#	in	Presence detect, PCIe lane 1.4
	[1.4]_PE_CLK-, [1.4]_PE_CLK+	out	Differential 100 MHz Reference Clock, PCIe lane 1.4

2.15.2.1 Power Supply Status (*DEG#*, *FAIL#*)

Power supply failures may be detected before the system crashes down by monitoring the signals *DEG#* or *FAIL#*. These active-low lines are additions of the CompactPCI specification and may be driven by the power supply. *DEG#* signals the degrading of the supply voltages, *FAIL#* their possible failure.

2.16 Reset Button and Status LED

The F19P has a reset button and one status LED at the front panel. The reset button is recessed within the front panel and requires a tool, e.g. paper clip to be pressed, preventing the button from being inadvertently activated.

The yellow status LED shows board status messages. The LED is controlled by a GPIO pin of the board controller. It is switched on when the BIOS starts, switched off when the board is switched off and flashing when the board is in stand-by (S3) status.

During normal operation the LED can be switched on and off using the MEN driver for the board controller.



See [MEN's website](#) for further information.

In case of a board failure, the LED displays the following error messages:

Table 15. Error codes signaled by board management controller via LED flashes

Number of Flashes	Error	Description
1	XM02BCI_ERR_33A	3.3 V failure
2	XM02BCI_ERR_INP	Input voltage failure
3	XM02BCI_ERR_NO_EXT_PWR_OK	External power supply failure
4	XM02BCI_ERR_ICH_HANDSHAKE	Chipset handshake failure
5	XM02BCI_ERR_NO_DDRVR_PWRGD	Memory voltage failure
6	XM02BCI_ERR_NO_PWRGD_5130	1.05 V or internal 3.3 V voltage failure
7	XM02BCI_ERR_NO_IMVP_PWRGD	CPU voltage failure
8	XM02BCI_ERR_NO_GFX_PWRGD	Graphic voltage failure
9	XM02BCI_ERR_PLT_RST_TIMEOUT	Platform reset timeout
10	XM02BCI_ERR_CPU_RST_TIMEOUT	CPU Reset timeout
11	XM02BCI_ERR_BIOS_TIMEOUT	BIOS timeout
12	XM02BCI_ERR_CPU_TOO_HOT	CPU too hot
255	CPUBCI_INVALID_MAIN_STATE	Invalid PIC main state

3 BIOS

The F19P is equipped with an InsydeH2O setup utility from Insyde Software. InsydeH2O is Insyde Software's firmware product line designed to replace traditional PC BIOS. It is an implementation of the Intel's Platform Innovation Framework for UEFI /EFI. The UEFI/EFI specification defines a new model for the interface between operating systems and platform firmware. This interface consists of data tables that contain platform-related information, plus boot and runtime service calls that are available to the operating system and its loader. Together, these provide a standard environment for booting an operating system and running pre-boot applications. This product line is the next generation of PC BIOS technology.

The ">" character in front of a menu item means that a sub-menu is available. An "x" in front of a menu item means that there is a configuration option which needs to be activated through a higher configuration option before being accessible.

3.1 Main

InsydeH2O Setup Utility				Rev. 3.5	
Main	Advanced	Security	Power	Boot	Exit
InsydeH2O Version		F19P BIOS V 1.xx			
Processor Type		Intel Celeron M CPU 722 @ 1.20GHz			
System Bus Speed		800MHz			
System Memory Speed		800MHz			
Cache RAM		1024kB			
Total Memory		2048MB			
SODIMM 0		1024MB			
SODIMM 1		1024MB			
System Time		[hh:mm:ss]			
System Date		[mm/dd/yyyy]			
F1 Help	↑↓ Select Item	F5/F6 Change Values	F9 Setup Defaults		
Esc Exit	← → Select Menu	Enter Select > Submenu	F10 Save and Exit		

InsydeH2O Version / MEN Board / Processor Type / System Bus Speed / System Memory Speed / Cache RAM/ Total Memory/ SODIMM 0 / SODIMM 1

Description You cannot change any values in these fields. They are only for information.

Language

Description Select the default language

Options *English*

System Time

Description Change the internal clock.

Options	<i>hh</i>	Hours (Valid range from 0 to 23)
	<i>mm</i>	Minutes (Valid range from 0 to 59)
	<i>ss</i>	Seconds (Valid range from 0 to 59)

System Date

Description	Change the date	
Options	<i>mm</i>	Month (Valid range from 1 to 12)
	<i>dd</i>	Day (Valid range from 1 to 31)
	<i>yyyy</i>	Year (Valid range from 2000 to 2099)

3.2 Advanced

InsydeH2O Setup Utility				Rev. 3.5	
Main	Advanced	Security	Power	Boot	Exit
<ul style="list-style-type: none"> >Boot Configuration >Peripheral Configuration >IDE Configuration >Video Configuration >USB Configuration >Chipset Configuration >ACPI Table/Features Control >PCI Express Root Port 1 >PCI Express Root Port 2 >PCI Express Root Port 3 >PCI Express Root Port 4 >PCI Express Root Port 5 >PCI Express Root Port 6 					
F1 Help	↑↓ Select Item		F5/F6 Change Values	F9 Setup Defaults	
Esc Exit	← → Select Menu		Enter Select > Submenu	F10 Save and Exit	

Boot Configuration — Sub-menu

NumLock	[On]
Power Supply Type	[AT]
Watchdog	[Off]
SMI Handler	[On]
PWRON after PWR-Fail	[On]
ATX_PWRGD Failure Mode	[Check at Start-Up]
Spread Spectrum Control	[On]
MEN F19P Settings	
SATA-4 Switch	[On]
x Port Switch	[Port A]
PCIe Switch	[On]

Numlock

Description Selects power-on state for Numlock

Options *On* *Off*

Power Supply Type

Description Selects the type of power supply

Options *AT* *ATX*

Watchdog

Description Enables or disables the F19P Watchdog

Options *Off* *10 min*
1 min *15 min*
2 min *20 min*
5 min *30 min*

SMI Handler

Description Enables or disables the SMI functionality

Options *On* *Off*

PWRON after PWR-Fail

Description Sets the system power status when power returns to the system from a power failure situation.

Options *On* *Off*
Former State

ATX_PWRGD Failure Mode

Description Determines the system behavior in case of a failure at the ATX power good signal

Options *Check at Start-Up* *Check always*

Spread Spectrum Control

Description Enable or disable Spread Spectrum

Options *On* *Spread Spectrum enabled*

	<i>Off</i>	Spread Spectrum disabled
MEN F19P Settings		
SATA-4 Switch		
Description	Switch for the SATA-4 interface.	
Options	<i>On</i>	SATA-4 available at side card
	<i>Off</i>	SATA-4 available at rear I/O
Port Switch		
Description	Select one of the two available ports on the side card (only if menu item SATA-4 Switch is [On])	
Options	<i>Port A</i>	SATA Port A is selected
	<i>Port B</i>	SATA Port B is selected
PCIe Switch		
Description	Switch for the PCIe Ports 1-4.	
Options	<i>On</i>	PCIe Ports 1-4 are routed to the side card.
	<i>Off</i>	PCIe Ports are routed to rear I/O

Peripheral Configuration — Sub-menu

HD Audio	[Auto]
LAN-1	[On]
LAN-2	[On]
F19P Settings	
>LAN-3	[On]

HD Audio

Description Enable or disable the HD Audio controller.

Options	<i>Auto</i>	The controller is enabled if a codec is found.
	<i>Disabled</i>	The controller is disabled even when there is an audio codec.
	<i>Enabled</i>	The controller is enabled independent of the presence of a codec.

LAN-1/LAN-2/LAN-3

Description Enables or disables the LAN interfaces.

Options	<i>On</i>	<i>Off</i>
----------------	-----------	------------

IDE Configuration — Sub-menu

```

IDE Controller           [Enabled]
Delay for HDD            [Off]
Force SATA Speed to Gen-1
(1.5 Gb/s)              [Disabled]
HDC Configure as        [AHCI]
SGPIO Interface         [Off]
SATA Port 0 - HotPlug   [Enabled]
Port 0 External         [Disabled]
SATA Port 1 - HotPlug   [Enabled]
Port 1 External         [Disabled]
SATA Port 2 - HotPlug   [Enabled]
Port 2 External         [Disabled]
SATA Port 3 - HotPlug   [Enabled]
Port 3 External         [Disabled]
>Serial ATA Port 1      [ST9160310AS]
    Type:                [Auto]

    32Bit I/O:           [Enabled]
    Block Mode:          [Enabled]
    Transfer Mode:       [Ultra DMA ATA-100]
    Security Mode:       Uninstall
>Serial ATA Port 2      [ST960817SM]
    Type:                [Auto]

    32Bit I/O:           [Enabled]
    Block Mode:          [Enabled]
    Transfer Mode:       [Ultra DMA ATA-100]
    Security Mode:       Uninstall
>Serial ATA Port 3      [Not Installed]
>Serial ATA Port 4      [Not Installed]
    
```

IDE Controller

Description Enables or disables the IDE controllers.

Options *Enabled* *Disabled*

Delay for HDD

Description Sets the delay for spin-up of the hard disk in seconds.

Options *Off* *1 sec*
 2 sec *3 sec*
 4 sec *5 sec*
 6 sec *7 sec*
 8 sec *9 sec*
 10 sec

Force SATA Speed to Gen-1 (1.5 Gb/s)

Description Enabled: The SATA speed is forced to 1.5 Gb/s.
 Disabled: The max. SATA speed is 3.0 Gb/s.

Options *Enabled* *Disabled*

HDC Configure as**Description** Set hard disk controller configure type.**Options** *IDE* *RAID*
*AHCI***SGPIO Interface****Description** Starts the chipset's SGPIO functionality. SGPIO is, e.g., required for the hot-plug functionality of SATA HDDs, if the Intel Rapid Storage Manager is used under Windows. Only available if item HDC Configure as is set to AHCI.**Options** *on* *off***SATA Port 0/1/2/3 Hot Plug****Description** This setting indicates that the port is hot-plug capable. Only available if item HDC Configure as is set to AHCI.**Options** *Enabled* *Disabled***Port 0/1/2/3 External****Description** This setting indicates that the port is an external SATA port. Only available if item HDC Configure as is set to AHCI.**Options** *Enabled* *Disabled***Serial ATA Port 1/2****Type****Description** When the option user-defined is set, the items 32Bit I/O, Block Mode and Transfer Mode can be modified.**Options** *Auto* *User-defined***32Bit I/O****Description** Enable/disable 32Bit I/O.**Options** *Enabled* *Disabled***Block Mode****Description** Enable/disable Block Mode.**Options** *Enabled* *Disabled***Transfer Mode****Description** Sets the Transfer Mode.**Options** *Auto* *Fast PIO*
Ultra DMA ATA-33 *Ultra DMA ATA-66*
Ultra DMA ATA-
*100***Security Mode****Description** No changes can be made here.

Options *Uninstall*

Serial ATA Port 3/4

Description Not installed. You can make no changes here.

Video Configuration — Sub-menu

Render Standby	[Enabled]
Render Thermal Throttling	[Enabled]
IGD - Device2, Function1	[Enabled]
IGD - Pre-allocated Memory	[UMA = 64MB]
IGD - DVMT Size	[DVMT Max]
IGD - Boot Type	[VBIOS Default]
IGD - LCD Panel Type	[1024x768 LVDS]
IGD - PAVP Mode	[Lite]
IGD - Gfx Low Power Mode	[Enabled]
Primary Video	[PEG]

Render Standby

Description Check to enable render standby support.

Options *Enabled* *Disabled*

Render Thermal Throttling

Description This feature is applicable for Graphic SKUs only

Options *Enabled* *Disabled*

IGD - Device2, Function1

Description Enable/Disable function 1 of the internal graphics device by setting item to the desired value

IGD - Pre-allocated Memory

Description Select the amount of pre-allocated memory that the Internal Graphics Device will use. Warning: Some feature may not be supported with 1MB pre-allocated memory.

Options *UMA = 32 MB* *UMA = 64 MB*

IGD - DVMT Size

Description Select the size of DVMT 3.0 that the Internal Graphics Device will use

Options *64 MB* *128 MB*
224MB

IGD - Boot Type

Description Select the Video Device that will be activated during POST

Options *VBIOS Default* *CRT*
LFP *CRT+LFP*
TV *LFP-SDVO*
EFP *TV-SDVO*
CRT+LFP-SDVO *CRT+EFP*

IGD - LCD Panel Type

Description Select the panel used by the Internal Graphics Device

Options *640x480 LVDS* *800x600 LVDS*

	1024x768 LVDS	1280x1024 LVDS
	1400x1050 LVDS1	1400x1050 LVDS2
	1600x1200 LVDS	
IGD - PAVP Mode		
Description	GMCH protected audio video path BIOS support	
Options	Disabled	Lite
	High	
IGD - Gfx Low Power Mode		
Description	Applicable for SFF only	
Options	Enabled	Disabled
Primary Video		
Description	Primary Video Mode for Video Output	
Options	IGD	PEG
	PCI	PCIe

USB Configuration — Sub-menu

USB Legacy	[Enabled]
EHCI 1	[Enabled]
EHCI 2	[Enabled]
UHCI 1	[Enabled]
UHCI 2	[Enabled]
UHCI 3	[Enabled]
UHCI 4	[Enabled]
UHCI 5	[Enabled]
UHCI 6	[Enabled]
Pre-Port Control	[Disabled]
USB Pre-fetch Feature	[Enabled]
USB Pre-fetch Time	[2ms]
USB HC Alignment	[Enabled]

USB Legacy

Description If this menu item is enabled it is possible to boot from USB devices and use a USB keyboard under DOS. Cannot be changed.

Options *Enabled*

EHCI 1/2

Description Enable/Disable EHCI 1/2.

Options *Enabled* *Disabled*

UHCI 1

Description Enable UHCI 1. Cannot be changed.

Options *Enabled*

UHCI 2/3/4/5/6

Description Enable UHCI 2/3/4/5/6.

Options *Enabled* *Disabled*

Pre-Port Control

Description Enable/Disable the per port disable control override

Options *Enabled* *Disabled*

USB Pre-fetch Feature

Description Enable/Disable the USB pre-fetch Feature

Options *Enabled* *Disabled*

USB Pre-fetch Time

Description Select the USB pre-fetch time.

Options *2ms* *4ms*

USB HC Alignment

Description Enable/Disable the USB HC Alignment.

Options *Enabled* *Disabled*

Chipset Configuration

```

Setup warning
Setting items on this screen to incorrect values may cause your system
to malfunction!

CRID [Enabled]
DMI Link ASPM Control [Enabled]
Automatic ASPM [Auto]
Manual:-----
ASPM L0s Support [Disabled]
ASPM L0sL1 Support [Disabled]
-----
VT-d [Enabled]
System Memory Frequency [Auto]

>Memory Thermal Management
  TM Mode [Disabled]
  TS on DIMM [Disabled]
  TM lock [Disabled]
    
```

CRID

Description Enable or disable : Compatible Revision ID (CRID) / Stepping Revision ID (SRID)

Options *Enabled* *Disabled*

DMI Link ASPM Control

Description Enable or disable the control of Active State Power Management on both GMCH side and ICH8M side of the DMI Link.

Options *Enabled* *Disabled*

Automatic ASPM

Description Automatically or manually control the level of ASPM supported on the DMI Link.

Options *Auto* *Manual*

ASPM L0s Support

Description Control L0s Entry Support on the DMI Link

Options *Enabled* *Disabled*

ASPM L0sL1 Support

Description Control L0s and L1 Entry Support on the DMI Link

Options *Enabled* *Disabled*

VT-d

Description Check to enable VT-d function on MCH

Options *Enabled* *Disabled*

System Memory Frequency

Description Determines the System Memory Frequency.

Options *Auto* No change in System Memory Frequency.

667MHz	System Memory Frequency fixed at 667MHz.
Memory Thermal Management	
Description	Configure Memory Thermal Management
TM Mode	
Description	Select TM mode. Cannot be changed.
Options	<i>Disabled</i>
TS on DIMM	
Description	Enable or disable TS on DIMM. Cannot be changed.
Options	<i>Disabled</i>
TM Lock	
Description	Enable or disable TM Lock. Cannot be changed.
Options	<i>Disabled</i>

ACPI Table/Feature Control

FACP - C2 Latency Value	[Disabled]
FACP - C3 Latency Value	[Disabled]
FACP - RTC S4 Wakeup	[Enabled]
APIC - IO APIC Mode	[Enabled]
HPET - HPET Support	[Enabled]
Enabled:-----	
xBase Address select	[FED00000h]

FACP - C2 Latency Value

Description Value only for ACPI. Select the value for the P_LVL2_LAT field found in the FACP Table where: 1 = C2 Enabled, 101 = C2 Disabled

Options *Enabled* *Disabled*

FACP - C3 Latency Value

Description Value only for ACPI. Select the value for the P_LVL3_LAT field found in the FACP Table where: 57 = C3 Enabled, 1001 = C3 Disabled

Options *Enabled* *Disabled*

FACP - RTC S4 Wakeup

Description Value only for ACPI. Enable/Disable for S4 Wakeup from RTC

Options *Enabled* *Disabled*

APIC - IO APIC Mode

Description This item is valid only for WIN2k and WINXP. Also, a fresh install of the OS must occur when APIC Mode is desired. Test the IO ACPI by setting item to Enable. The APIC Table will then be pointed to by the RSDT, the Local APIC will be initialized, and the proper enable bits will be set in ICH4M.

Options *Enabled* *Disabled*

HPET - HPET Support

Description High Performance Event Timer Support in Windows XP. If this feature is enabled, the HPET table will be added into the ACPI Tables.

Options *Enabled* *Disabled*

Base Address Select

Description Memory address ranges of High Performance Event Timer. Only available if HPET support is enabled.

Options FED00000h FED10000h
 FED20000h FED30000h

PCI Express Root Port 1/2/3/4/5/6 Settings

PCI Express Root Port 1	[Enabled]
VC1 Enable	[Disabled]
ASPM	[Enabled]
URR	[Disabled]
FER	[Disabled]
NFER	[Disabled]
CER	[Disabled]
CTO	[Disabled]
SEFE	[Disabled]
SENF	[Disabled]
SECE	[Disabled]
PME Interrupt	[Disabled]
PME SCI	[Disabled]
Hot Plug SCI	[Disabled]

PCI Express Root Port 1/2/3/4/5/6

Description If PCI Express Root Port 1 is disabled, PCI Express Root Ports 2 to 6 will also be disabled.

Options *Enabled* *Disabled*

VC1 Enable

Description Enable or disable Virtual Channel 1.

Options *Disabled* *Auto*

ASPM

Description Enable ASPM settings.

Options *Enabled* *Disabled*

URR

Description Enable or disable PCI Express Unsupported Request Reporting.

Options *Enabled* *Disabled*

FER

Description Enable or disable PCI Express Device Fatal Error Reporting.

Options *Enabled* *Disabled*

NFER

Description Enable or disable Device Non-Fatal Error Reporting.

Options *Enabled* *Disabled*

CER

Description Enable or disable PCI Express Device Correctable Error Reporting.

Options *Enabled* *Disabled*

CTO

Description Enable or disable PCI Express Completion Timer.

Options *Enabled* *Disabled*

SEFE	
Description	Enable or disable Root PCI Express System Error on Fatal Error.
Options	<i>Enabled</i> <i>Disabled</i>
SENF	
Description	Enable or disable Root PCI Express System Error on Non-Fatal Error.
Options	<i>Enabled</i> <i>Disabled</i>
SECE	
Description	Enable or disable Root PCI Express System Error on Correctable Error.
Options	<i>Enabled</i> <i>Disabled</i>
PME Interrupt	
Description	Enable or disable Root PCI Express PME Interrupt.
Options	<i>Enabled</i> <i>Disabled</i>
PME SCI	
Description	Enable or disable PME SCI.
Options	<i>Enabled</i> <i>Disabled</i>
Hot Plug SCI	
Description	Enable or disable PCI Express Hot Plug SCI.
Options	<i>Enabled</i> <i>Disabled</i>

3.3 Security

InsydeH2O Setup Utility				Rev. 3.5	
Main	Advanced	Security	Power	Boot	Exit
TPM Status		Not Installed			
TPM Operation		[No Operation]			
Supervisor Password		[Installed/Not Installed]			
User Password		[Installed/Not Installed]			
Set Supervisor Password					
Power on password		[Disabled]			
User Access level		[View Only]			
Set User Password					
Clear User Password					
F1 Help		↑↓ Select Item		F5/F6 Change Values	
Esc Exit		← → Select Menu		F9 Setup Defaults	
				Enter Select >	
				F10 Save and Exit Submenu	

TPM Status

Description	TPM (Trusted Platform Module) Status. Not supported on the F19P.
Options	<i>Not installed</i>

TPM Operation

Description	TPM (Trusted Platform Module) Operation. Not supported on the F19P.
Options	<i>No operation</i>

Supervisor Password

Description	Shows whether a supervisor password has been entered.
--------------------	---

User Password

Description	Shows whether a user password has been entered.
--------------------	---

Set Supervisor Password

Description Enter and confirm the supervisor password under this menu item. To delete the password enter an empty password.

Power On Password

Description Select when the password has to be entered.

Options	<i>Enabled</i>	The password has to be entered when the system starts.
	<i>Disabled</i>	The password has to be entered when changing to the setup menu.

User Access Level

Description Set the User Access Level.

Options	<i>View Only</i>	Access to InsydeH2O Setup allowed but the fields cannot be changed.
	<i>Full</i>	Any field can be changed except the Supervisor password.
	<i>Limited</i>	Only limited fields can be changed.

Set User Password

Description Enter and confirm the user password under this menu item.

Clear User Password

Description Clear the user password. Only possible for a supervisor or user in the access levels full or limited.

3.4 Power

InsydeH2O Setup Utility				Rev. 3.5	
Main	Advanced	Security	Power	Boot	Exit
>Advanced CPU Control >Platform Power Management >Break Event					
ACPI S3		[Enabled]			
Wake on PME		[Disabled]			
Wake on Lan		[Disabled]			
Auto Wake on S5		[Disabled]			
F1 Help	↑↓ Select Item		F5/F6 Change Values	F9 Setup Defaults	
Esc Exit	← → Select Menu		Enter Select > Submenu	F10 Save and Exit	

Advanced CPU Control – Sub-Menu

TXT	[Disable]
P-States(IST)	[Enabled]
Boot Performance Mode	[Max Performance]
Thermal Mode	[Disabled]
CMP Support	[Auto]
Use XD Capability	[Enabled]
VT Support	[Disabled]
SMRR Support	[Auto]
C-States	[Enabled]
Enhanced C-States	[Enabled]
C-State Pop Up Mode	[Enabled]
C-State Pop Down Mode	[Enabled]
C4 Exit Timing Mode	[Fast]
DeepC4	[Enabled]
Hard C4E	[Enabled]
Enable C6	[Enabled]
EMTTM	[Enabled]
Dynamic FSB Switching	[Enabled]
Turbo Mode	[Enabled]
ACPI 3.0 T-States	[Disabled]
DTS	[Enabled]
DTS Calibration	[Enabled]
>Thermal Trip Points Setting	
Throttle On Temperature	[850C]

TXT

Description Enables utilization of additional hardware capabilities provided by Intel Trusted Execution Technology; changes require a full power cycle to take effect.

Options *Enabled* *Disabled*

P-States (IST)

Description Enable processor performance states (P-States).

Options *Enabled* *Disabled*

Boot Performance Mode

Description Select the performance state that BIOS will set before OS handoff.

Options *Max Performance* *Max Battery*

Thermal Mode

Description Select the Thermal Mode.

Options *Disabled* *TM1*
 TM2 *TM1 and TM2*

CMP Support

Description Enable or disable core multi processing.

Options	<i>Auto</i>	<i>Disabled</i>
Use XD Capability		
Description	Enable or disable XD capability.	
Options	<i>Enabled</i>	<i>Disabled</i>
VT Support		
Description	Enable or disable Vanderpool technology.	
Options	<i>Enabled</i>	<i>Disabled</i>
SMRR Support		
Description	Enable or disable SMRR Support.	
Options	<i>Auto</i>	<i>Disabled</i>
C-States		
Description	Enable processor idle power saving states (C-States).	
Options	<i>Enabled</i>	<i>Disabled</i>
Enhanced C-States		
Description	Enable P-State transitions to occur in combination with C-States.	
Options	<i>Enabled</i>	<i>Disabled</i>
C-State Pop Up Mode		
Description	If enabled and ICH observes a bus master request, it will take the system from C3/C4 to C2 and auto enable bus masters. If disabled, bus master traffic is a break event and ICH will attempt to return to C0 state.	
Options	<i>Enabled</i>	<i>Disabled</i>
C-State Pop Down Mode		
Description	If enabled and ICH observes no bus master requests, it can return to the previous C3/C4 state. If disabled, ICH will not attempt to automatically return to the previous C3/C4 state.	
Options	<i>Enabled</i>	<i>Disabled</i>
C4 Exit Timing Mode		
Description	This option controls a programmable time for the CPU voltage to stabilize when exiting from a C4 state.	
Options	<i>Fast</i>	<i>Default</i>
	<i>Slow</i>	<i>Force Slow</i>
DeepC4		
Description	Enable Deep C4 with L2 Cache disable instead of C4.	
Options	<i>Enabled</i>	<i>Disabled</i>
Hard C4E		

Description	Enable P-State transitions to minimum state on C4E.	
Options	<i>Enabled</i>	<i>Disabled</i>
Enable C6		
Description	Enables or disables the C6 state (Deep Power Down Technology).	
Options	<i>Enabled</i>	<i>Disabled</i>
EMTTM		
Description	Enable processor Enhanced Multi Threaded Thermal Monitoring (requires GV3).	
Options	<i>Enabled</i>	<i>Disabled</i>
Dynamic FSB Switching		
Description	Enable or disable processor Dynamic FSB Frequency Switching (Bus GV)	
Options	<i>Enabled</i>	<i>Disabled</i>
Turbo Mode		
Description	Enable processor Turbo Mode (requires EMTTM enabled too).	
Options	<i>Enabled</i>	<i>Disabled</i>
ACPI 3.0 T-States		
Description	Enable or disable ACPI 3.0 T-States	
Options	<i>Enabled</i>	<i>Disabled</i>
DTS		
Description	Enables CPU Digital Thermal Sensor function.	
Options	<i>Enabled</i>	<i>Disabled</i>
DTS Calibration		
Description	Enables Calibration function.	
Options	<i>Enabled</i>	<i>Disabled</i>
>Thermal Trip Points Setting		
Throttle On Temperature		
Description	Set the CPU temperature point at which the throttle is activated.	
Options	40°C	45°C
	50°C	55°C
	60°C	65°C
	70°C	75°C
	80°C	85°C
	90°C	

Platform Power Management – Sub-Menu

PCI Clock Run	[Enabled]
PCI Clock Run	
Description	If Enabled, the CLKRUN# Logic will stop the PCI Clocks.
Options	<i>Enabled</i> <i>Disabled</i>

Break Event – Sub-Menu

Storage Break Event	[Disabled]
PCIE Break Event	[Disabled]
PCI Break Event	[Disabled]
EHCI Break Event	[Disabled]
UHCI Break Event	[Disabled]
HDA Break Event	[Disabled]
Storage Break Event	
Description	If Enabled, Parallel IDE or Serial ATA master activity will cause BM_STS to be set and will cause a break from C3/C4.
Options	<i>Enabled</i> <i>Disabled</i>
PCIE Break Event	
Description	If Enabled, PCI Express master activity will cause BM_STS to be set and will cause a break from C3/C4.
Options	<i>Enabled</i> <i>Disabled</i>
PCI Break Event	
Description	If Enabled, PCI master activity will cause BM_STS to be set and will cause a break from C3/C4.
Options	<i>Enabled</i> <i>Disabled</i>
EHCI Break Event	
Description	If Enabled, EHCI master activity will cause BM_STS to be set and will cause a break from C3/C4.
Options	<i>Enabled</i> <i>Disabled</i>
UHCI Break Event	
Description	If Enabled, UHCI master activity will cause BM_STS to be set and will cause a break from C3/C4.
Options	<i>Enabled</i> <i>Disabled</i>
HDA Break Event	
Description	If Enabled, Intel High Definition Audio master activity will cause BM_STS to be set and will cause a break from C3/C4.
Options	<i>Enabled</i> <i>Disabled</i>

ACPI S3

Description	Enable/Disable ACPI S1/S3 Sleep state
--------------------	---------------------------------------

Options	<i>Enabled</i>	<i>Disabled</i>
----------------	----------------	-----------------

Wake on PME

Description	Determines the action taken when the system power is off and a PCI Power Management Enable wake up event occurs.
--------------------	--

Options	<i>Enabled</i>	<i>Disabled</i>
----------------	----------------	-----------------

Wake on Lan

Description	Determines the action taken when the system power is off and a Wake on Lan event occurs.
--------------------	--

Options	<i>Enabled</i>	<i>Disabled</i>
----------------	----------------	-----------------

Auto Wake on S5

Description	Auto wake on S5, By Day of Month or Fixed time of every day
--------------------	---

Options	<i>Disabled</i>	<i>By every day</i>
	<i>By day of month</i>	

3.5 Boot

InsydeH2O Setup Utility				Rev. 3.5
Main	Advanced	Security	Power	Boot
UEFI Boot			[Enabled]	
Quick Boot			[Enabled]	
Quiet Boot			[Enabled]	
PXE Boot to LAN			[Disabled]	
ACPI Selection			[ACPI 3.0]	
USB Boot			[Enabled]	
>EFI				
>Legacy				
F1 Help	↑↓ Select Item		F5/F6 Change Values	F9 Setup Defaults
Esc Exit	← → Select Menu		Enter Select > Submenu	F10 Save and Exit

UEFI Boot

Description	Enable/Disable UEFI Boot Function	
Options	<i>Enabled</i>	<i>Disabled</i>

Quick Boot

Description	Allows InsydeH2O to skip certain tests while booting. This will decrease the time needed to boot the system.	
Options	<i>Enabled</i>	<i>Disabled</i>

Quiet Boot

Description	Disables or enables booting in Text Mode	
Options	<i>Enabled</i>	<i>Disabled</i>

PXE Boot to LAN

Description	Disables or enables PXE boot to LAN.	
--------------------	--------------------------------------	--

Options	<i>Enabled</i>	<i>Disabled</i>
----------------	----------------	-----------------

ACPI Selection

Description	Select booting to Acpi3.0/Acpi1.0B	
--------------------	------------------------------------	--

Options	Acpi3.0/	Acpi1.0B
----------------	----------	----------

USB Boot

Description	Disables or enables booting to USB boot devices.	
--------------------	--	--

Options	<i>Enabled</i>	<i>Disabled</i>
----------------	----------------	-----------------

EFI – Sub-Menu

EFI
Windows Boot Manager

EFI Boot Menu

Description	Selects the boot order for (U)EFI boot media. Windows 7 64-Bit can be installed in UEFI mode, for example.
--------------------	--

Legacy – Sub-Menu

Boot Device Priority	
> Normal Boot Menu	[Normal/Advance]
Normal	Advance
> Boot Type Order	KingstonDataTraveler G3
Floppy Drive Hard Disk Drive CD/DVD-ROM Drive USB Others	
> USB	KingstonDataTraveler G3

Normal Boot Menu

Description	Selects the type of boot order	
Options	<i>Normal</i>	Sub-menu Boot Type Order: Under this menu option it is possible to select the boot order of device groups (e.g. Hard Disk before Floppy Drive). Sub-menu USB: Under this menu option it is possible to select the boot order of single devices within a device group, e.g. USB-HDD before SATA-HDD
	<i>Advance</i>	Under this menu option there are no device groups. The single devices are listed and can be moved to select the boot order, e.g.: SATA-HDD1 USB-Floppy USB-DVD-DRIVE SATA-HDD2

3.6 Exit

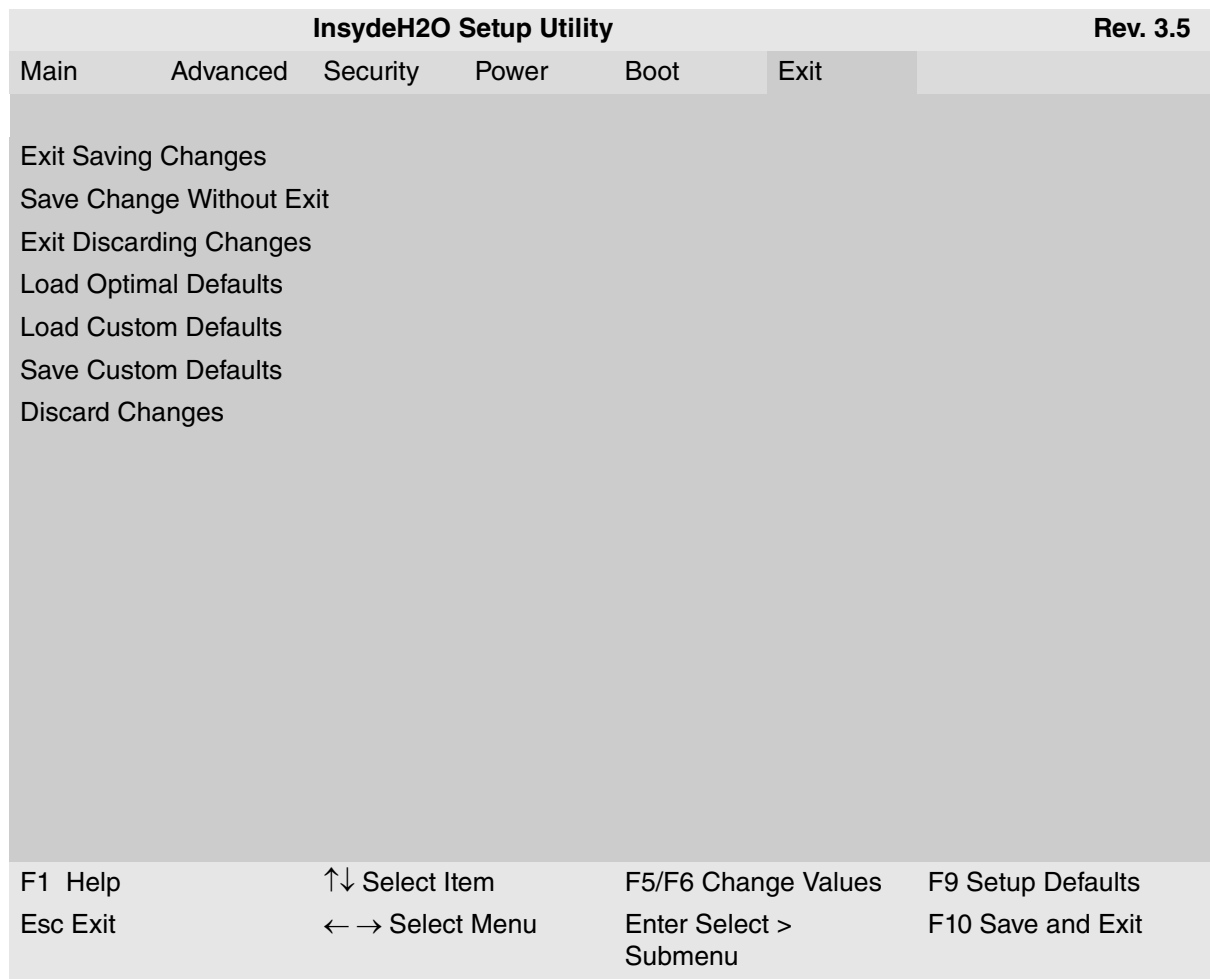

3.6.1 Exit Saving Changes

Exit system setup and save your changes.

3.6.2 Save Change Without Exit

Save your changes without exiting the system.

3.6.3 Exit Discarding Changes

Exit system setup without saving your changes.

3.6.4 Load Optimal Defaults

If this option is selected, a verified factory setup is loaded.

On the first BIOS setup configuration, this loads safe values for setup, which make the board boot up.

3.6.5 Load Custom Defaults

If this option is selected the custom defaults that have been saved in a former session with Save Custom Defaults are loaded.

See [Chapter 3.6.6 Save Custom Defaults](#) for further information.

3.6.6 Save Custom Defaults

Save custom defaults.

3.6.7 Discard Changes

Discard changes.

4 Organization of the Board

4.1 Memory Mappings

4.1.1 Processor View of the Memory Map

The memory map is allocated dynamically and may vary depending on the system configuration.

Table 16. Memory map – processor view

CPU Address Range	Description
0xA0000-0xBFFFF	PCI bus
0xA0000-0xBFFFF	VGA Display Controller
0x80000000-0xFEBFFFFFF	PCI bus
0x80000000-0xFEBFFFFFF	Standard VGA Graphics Adapter
0x96500000-0x965FFFFFF	PCI standard PCI-to-PCI bridge
0x96500000-0x965FFFFFF	Ethernet Controller
0x96520000-0x96523FFF	Ethernet Controller
0x90000000-0x903FFFFFF	Standard VGA Graphics Adapter
0x93400000-0x934FFFFFF	Video Controller
0x96605400-0x966057FF	Standard Enhanced PCI to USB Host Controller
0x96600000-0x96603FFF	Microsoft UAA Bus Driver for High Definition Audio
0x95500000-0x964FFFFFF	PCI standard PCI-to-PCI bridge
0x90400000-0x913FFFFFF	PCI standard PCI-to-PCI bridge
0x94500000-0x954FFFFFF	PCI standard PCI-to-PCI bridge
0x94500000-0x954FFFFFF	Ethernet Controller
0x91400000-0x923FFFFFF	PCI standard PCI-to-PCI bridge
0x94520000-0x94523FFF	Ethernet Controller
0x93500000-0x944FFFFFF	PCI standard PCI-to-PCI bridge
0x93500000-0x944FFFFFF	Ethernet Controller
0x92400000-0x933FFFFFF	PCI standard PCI-to-PCI bridge
0x93520000-0x93523FFF	Ethernet Controller
0x96605000-0x966053FF	Standard Enhanced PCI to USB Host Controller
0xF8000000-0xFBFFFFFF	Motherboard resources
0xFED1C000-0xFED1FFFF	Motherboard resources
0xFED10000-0xFED13FFF	Motherboard resources
0xFED18000-0xFED18FFF	Motherboard resources
0xFED19000-0xFED19FFF	Motherboard resources
0xFEC00000-0xFEC00FFF	Motherboard resources

CPU Address Range	Description
0xFED20000-0xFED3FFFF	Motherboard resources
0xFED40000-0xFED44FFF	Motherboard resources
0xFED45000-0xFED8FFFF	Motherboard resources
0xFEE00000-0xFEE00FFF	Motherboard resources
0xFED00000-0xFED003FF	High precision event timer
0xFF800000-0xFFFFFFFF	Intel(R) 82802 Firmware Hub Device
0x96605800-0x966058FF	SM Bus Controller
0x96604000-0x96604FFF	PCI Data Acquisition and Signal Processing Controller

4.1.2 I/O Memory Map

Table 17. Memory map - I/O

Address Range	Description
0x00000000-0x00000CF7	PCI bus
0x00000000-0x00000CF7	Direct memory access controller
0x00000D00-0x0000FFFF	PCI bus
0x00005000-0x00005FFF	PCI standard PCI-to-PCI bridge
0x00005000-0x00005FFF	Ethernet Controller
0x00006140-0x00006147	Standard VGA Graphics Adapter
0x000060C0-0x000060DF	Standard Universal PCI to USB Host Controller
0x000060A0-0x000060BF	Standard Universal PCI to USB Host Controller
0x00004000-0x00004FFF	PCI standard PCI-to-PCI bridge
0x00003000-0x00003FFF	PCI standard PCI-to-PCI bridge
0x00003000-0x00003FFF	Ethernet Controller
0x00002000-0x00002FFF	PCI standard PCI-to-PCI bridge
0x00002000-0x00002FFF	Ethernet Controller
0x00006080-0x0000609F	Standard Universal PCI to USB Host Controller
0x00006060-0x0000607F	Standard Universal PCI to USB Host Controller
0x00006040-0x0000605F	Standard Universal PCI to USB Host Controller
0x00006020-0x0000603F	Standard Universal PCI to USB Host Controller
0x00000061-0x00000061	Motherboard resources
0x00000070-0x00000070	Motherboard resources
0x00000070-0x00000070	System CMOS/real time clock
0x00000080-0x00000080	Motherboard resources
0x00000092-0x00000092	Motherboard resources
0x000000B2-0x000000B3	Motherboard resources
0x00000063-0x00000063	Motherboard resources

Address Range	Description
0x00000065 - 0x00000065	Motherboard resources
0x00000067 - 0x00000067	Motherboard resources
0x00000600 - 0x0000060F	Motherboard resources
0x00000610 - 0x00000610	Motherboard resources
0x00000800 - 0x0000080F	Motherboard resources
0x00000810 - 0x00000817	Motherboard resources
0x00000820 - 0x00000823	Motherboard resources
0x00000400 - 0x0000047F	Motherboard resources
0x00000500 - 0x0000053F	Motherboard resources
0x00000081 - 0x00000091	Direct memory access controller
0x00000093 - 0x0000009F	Direct memory access controller
0x000000C0 - 0x000000DF	Direct memory access controller
0x00000020 - 0x00000021	Programmable interrupt controller
0x00000024 - 0x00000025	Programmable interrupt controller
0x00000028 - 0x00000029	Programmable interrupt controller
0x0000002C - 0x0000002D	Programmable interrupt controller
0x00000030 - 0x00000031	Programmable interrupt controller
0x00000034 - 0x00000035	Programmable interrupt controller
0x00000038 - 0x00000039	Programmable interrupt controller
0x0000003C - 0x0000003D	Programmable interrupt controller
0x000000A0 - 0x000000A1	Programmable interrupt controller
0x000000A4 - 0x000000A5	Programmable interrupt controller
0x000000A8 - 0x000000A9	Programmable interrupt controller
0x000000AC - 0x000000AD	Programmable interrupt controller
0x000000B0 - 0x000000B1	Programmable interrupt controller
0x000000B4 - 0x000000B5	Programmable interrupt controller
0x000000B8 - 0x000000B9	Programmable interrupt controller
0x000000BC - 0x000000BD	Programmable interrupt controller
0x000004D0 - 0x000004D1	Programmable interrupt controller
0x000000F0 - 0x000000F0	Numeric data processor
0x00000040 - 0x00000043	System timer
0x00000050 - 0x00000053	System timer
0x00006138 - 0x0000613F	Standard Dual Channel PCI IDE Controller
0x00006154 - 0x00006157	Standard Dual Channel PCI IDE Controller
0x00006130 - 0x00006137	Standard Dual Channel PCI IDE Controller
0x00006150 - 0x00006153	Standard Dual Channel PCI IDE Controller
0x00006110 - 0x0000611F	Standard Dual Channel PCI IDE Controller

Address Range	Description
0x00006100-0x0000610F	Standard Dual Channel PCI IDE Controller
0x00006000-0x0000601	FSM Bus Controller
0x00006128-0x0000612F	Standard Dual Channel PCI IDE Controller
0x0000614C-0x0000614F	Standard Dual Channel PCI IDE Controller
0x00006120-0x00006127	Standard Dual Channel PCI IDE Controller
0x00006148-0x0000614B	Standard Dual Channel PCI IDE Controller
0x000060F0-0x000060FF	Standard Dual Channel PCI IDE Controller
0x000060E0-0x000060EF	Standard Dual Channel PCI IDE Controller
0x000003B0-0x000003BB	VGA Display Controller
0x000003C0-0x000003DF	VGA Display Controller
0x000001CE-0x000001CF	VGA Display Controller
0x000002E8-0x000002EF	VGA Display Controller

4.2 PCI Devices

Table 18. PCI Devices

Bus	Device Number	Device Function	Vendor ID	Device ID	Class	Function
0	0x00	0x0	0x8086	0x2A40	Host Bridge	Intel GS45 Chipset Processor to I/O Controller
	0x01	0x0	0x8086	0x2A41	PCI Bridge (0-1)	Intel GS45 Chipset PCIe Port Port 1
	0x02	0x0	0x8086	0x2A42	VGA Controller	Intel GS45 Chipset Integrated Graphics Controller 1
	0x02	0x1	0x8086	0x2A43	Non VGA Controller	Intel GS45 Chipset Integrated Graphics Controller 2
	0x26	0x0	0x8086	0x2937	UHCI USB Controller	Intel 82801IEM (ICH9M-E) USB UHCI Controller #4
	0x26	0x1	0x8086	0x2938	UHCI USB Controller	Intel 82801IEM (ICH9M-E) USB UHCI Controller #5
	0x26	0x7	0x8086	0x293C	EHCI USB Controller	Intel 82801IEM (ICH9M-E) USB EHCI Controller #2
	0x27	0x0	0x8086	0x293E	High Def Audio	Intel 82801IEM (ICH9M-E) HD Audio Controller
	0x28	0x0	0x8086	0x2940	PCI Bridge (0-2)	Intel 82801IEM (ICH9M-E) PCIe Port 1
	0x28	0x4	0x8086	0x2948	PCI Bridge (0-3)	Intel 82801IEM (ICH9M-E) PCIe Port 5
	0x28	0x5	0x8086	0x294A	PCI Bridge (0-4)	Intel 82801IEM (ICH9M-E) PCIe Port 6
	0x29	0x0	0x8086	0x2934	UHCI USB Controller	Intel 82801IEM (ICH9M-E) USB UHCI Controller #1
	0x29	0x1	0x8086	0x2935	UHCI USB Controller	Intel 82801IEM (ICH9M-E) USB UHCI Controller #2
	0x29	0x2	0x8086	0x2936	UHCI USB Controller	Intel 82801IEM (ICH9M-E) USB UHCI Controller #3
	0x29	0x3	0x8086	0x2939	UHCI USB Controller	Intel 82801IEM (ICH9M-E) USB UHCI Controller #6
	0x29	0x7	0x8086	0x293A	EHCI USB Controller	Intel 82801IEM (ICH9M-E) USB EHCI Controller #1
	0x30	0x0	0x8086	0x2448	PCI Subtractive (0-5)	Intel 82801IEM (ICH9M-E) Hub Interface to PCI Bridge
	0x31	0x0	0x8086	0x2917	ISA Bridge	Intel 82801IEM (ICH9M-E) LPC Interface Controller
	0x31	0x2	0x8086	0x2928	SATA Controller	Intel 82801IEM (ICH9M-E) 2 port SATA I/O Controller 1 cc=EIDE
	0x31	0x3	0x8086	0x2930	SMBus Controller	Intel 82801IEM (ICH9M-E) SMBus Controller
	0x31	0x5	0x8086	0x292D	Disk Controller	Intel 82801IEM (ICH9M-E) 2 port SATA I/O Controller 2 cc=EIDE
	0x31	0x6	0x8086	0x2932	Other DPIO Module	Intel 82801IEM (ICH9M-E) Thermal Subsystem

Bus	Device Number	Device Function	Vendor ID	Device ID	Class	Function
1	0x00	0x0	0x8086	0x10D3	Ethernet Controller	Intel 82574L Gigabit Network Connection
3	0x00	0x0	0x8086	0x10D3	Ethernet Controller	Intel 82574L Gigabit Network Connection
4	0x00	0x0	0x8086	0x10D3	Ethernet Controller	Intel 82574L Gigabit Network Connection

4.3 SMBus Devices

Table 19. SMBus devices

Address ¹	Function
0x9A / 0x9B	Board controller
0x98	Temperature sensor
0xA0	SPD of SO-DIMM (memory channel A)
0x60	Protect register
0xA4	SPD of SO-DIMM (memory channel B)
0x64	Protect register
0xAE	ID EEPROM
0x6E	Protect register
0xD2 / 0xD3	Clock generator

¹ The first address is for write command, the second for read command

4.4 Interrupt Mapping

Table 20. Interrupt Mapping

Interrupt	Function
IRQ 9	Microsoft ACPI-Compliant System
IRQ 16	PCI standard PCI-to-PCI bridge
IRQ 16	Standard Universal PCI to USB Host Controller
IRQ 16	PCI standard PCI-to-PCI bridge
IRQ 16	Standard Universal PCI to USB Host Controller
IRQ 11	Ethernet Controller
IRQ 11	Standard VGA Graphics Adapter
IRQ 11	Microsoft UAA Bus Driver for High Definition Audio
IRQ 11	Ethernet Controller
IRQ 11	Ethernet Controller
IRQ 11	SM Bus Controller
IRQ 11	PCI Data Acquisition and Signal Processing Controller
IRQ 21	Standard Universal PCI to USB Host Controller

Interrupt	Function
IRQ 19	Standard Enhanced PCI to USB Host Controller
IRQ 19	Standard Universal PCI to USB Host Controller
IRQ 19	Standard Dual Channel PCI IDE Controller
IRQ 19	Standard Dual Channel PCI IDE Controller
IRQ 17	PCI standard PCI-to-PCI bridge
IRQ 17	PCI standard PCI-to-PCI bridge
IRQ 23	Standard Universal PCI to USB Host Controller
IRQ 23	Standard Enhanced PCI to USB Host Controller
IRQ 18	Standard Universal PCI to USB Host Controller
IRQ 0	High precision event timer
IRQ 8	High precision event timer
IRQ 13	Numeric data processor

5 Maintenance

5.1 Lithium Battery



The board contains a lithium battery. There is a danger of explosion if the battery is incorrectly replaced! Replace only with the same or equivalent type.

- Manufacturer: Renata
- Type: CR2032
- Capacity: 220 mAh

The battery has to be UL listed.

Used batteries have to be disposed of according to the local regulations concerning the disposal of hazardous waste.

Figure 3. Position of battery on the CompactFlash adapter on the F19P

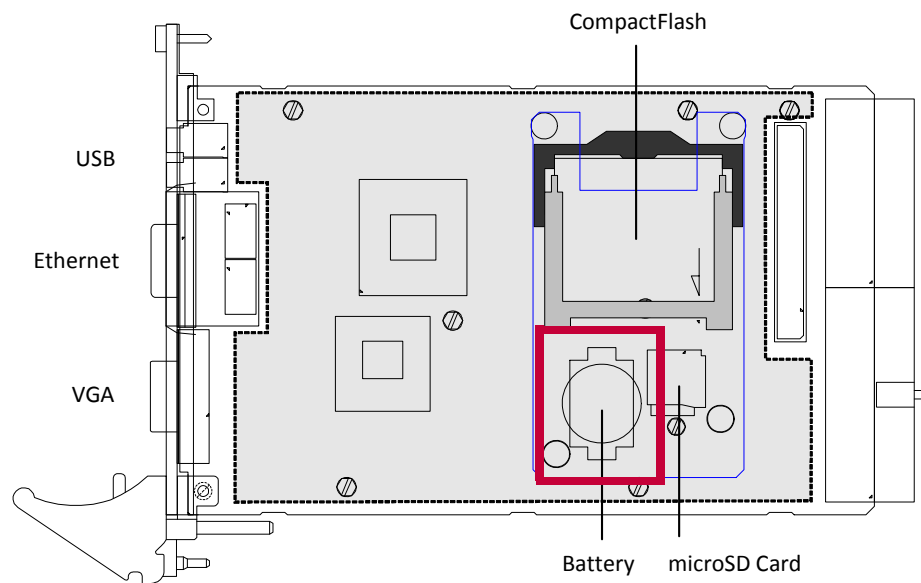

6 Appendix

6.1 Literature and Web Resources



[F19P data sheet](#) with up-to-date information and documentation.

6.1.1 CPU



[Intel Embedded Processors](#)

6.1.2 IDE

- EIDE:
Information Technology - AT Attachment-3 Interface (ATA-3), Revision 6, working draft; 1995; Accredited Standards Committee X3T10

6.1.3 SATA



[Serial ATA International Organization \(SATA-IO\)](#)

6.1.4 USB



[USB Implementers Forum, Inc.](#)

6.1.5 Ethernet

- ANSI/IEEE 802.3-1996, Information Technology - Telecommunications and Information Exchange between Systems - Local and Metropolitan Area Networks - Specific Requirements - Part 3: Carrier Sense Multiple Access with Collision Detection (CSMA/CD) Access Method and Physical Layer Specifications; 1996; IEEE



[ANSI/IEEE 802.3-1996](#)

- Charles Spurgeon's Ethernet Web Site



[Extensive information about Ethernet \(IEEE 802.3\) local area network \(LAN\) technology.](#)

- InterOperability Laboratory, University of New Hampshire



General Ethernet technology.

6.1.6 HD Audio



Intel High Definition Audio

6.1.7 PCI Express



PCI Special Interest Group

6.1.8 CompactPCI/PCI



CompactPCI PlusIO Specification PICMG 2.0 R3.0:
1999; PCI Industrial Computers Manufacturers Group (PICMG)



PCI Local Bus Specification Revision 2.2:
1995; PCI Special Interest Group
P.O. Box 14070
Portland, OR 97214, USA

6.1.9 CompactPCI PlusIO



CompactPCI PlusIO Specification PICMG 2.30 R1.0:
1999; PCI Industrial Computers Manufacturers Group (PICMG)



Introduction to [CompactPCI PlusIO on Wikipedia](#)

6.2 Finding out the Board's Article Number, Revision and Serial Number

MEN user documentation may describe several different models and/or hardware revisions of the F19P. You can find information on the article number, the board revision and the serial number on two labels attached to the board.

- **Article number:** Gives the board's family and model. This is also MEN's ordering number. To be complete it must have 9 characters.
- **Revision number:** Gives the hardware revision of the board.
- **Serial number:** Unique identification assigned during production.

If you need support, you should communicate these numbers to MEN.

Figure 4. Labels giving the board's article number, revision and serial number

